

PRODUCTION PROFILE

Litronix A Siemens Company

LED PRODUCT

INTERNATIONAL EDITION

**OPTOELECTRONICS
CATALOG
1982**

EUROPEAN OFFICE

Litronix, [U.K.] Ltd., 35, Bury Mead Road, Hitchin, Herts, SG5 1RT, England ● Telephone (0462) 56322/Telex 825497

U.S. HEADQUARTERS

Litronix, [U.K.] Ltd., 19000 Homestead Road, Cupertino, California 95014 ● Telephone (408) 257-7910/TWX 910-338-0022



Headquartered in Cupertino, California, Litronix designs, manufactures and markets optoelectronic components and related products worldwide.

Litronix [U.K.] Ltd., 1900 Homestead Road, Cupertino, California 95014 • Telephone (408) 527-7910/TWX 910-528-0023
U.S. HEADQUARTERS
Litronix [U.K.] Ltd., 38, Guy Meadows Road, Hitchin, Herts. SG5 1RT, England • Telephone (0462) 56322/Telex 324957
EUROPEAN OFFICE

PRODUCTION PROFILE

LED PRODUCTION

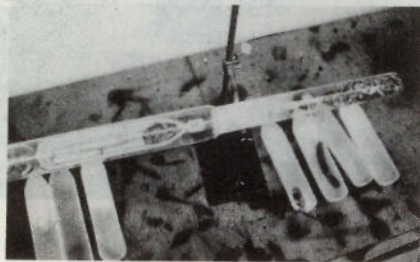

LED (light emitting diode) production, at the Cupertino facility, begins with ultra pure gallium and arsenic contained within a quartz boat (ampoule).



Ampoules are processed through a furnace.

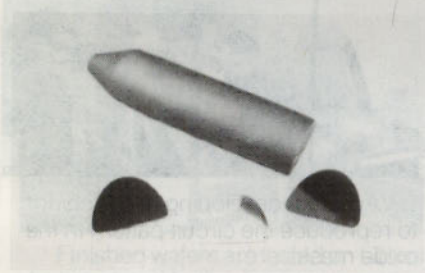

The resulting GaAs (gallium arsenide) ingot is sawed into wafers.



Wafers are lapped and polished to a mirror finish.

MANUFACTURING INTEGRATED CIRCUIT PRODUCTION

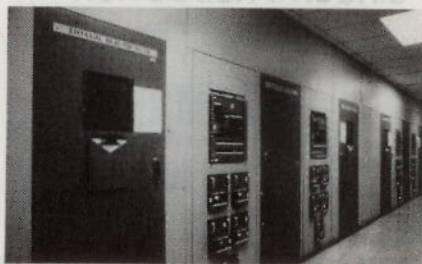

Polished wafers are put through EPI (epitaxial) reactors for vapor-phase epitaxial growth. The thin EPI layer is doped with phosphine to form a GaAsP (gallium arsenide phosphide) layer.

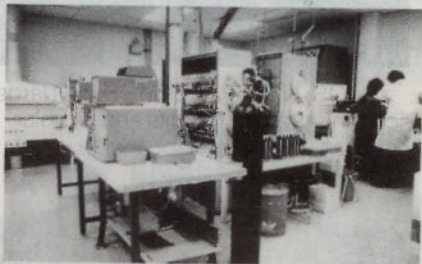

Next, the material passes through the photo masking and diffusion area. Patterns are etched through a masking silicon-nitride layer. Then a thin layer of zinc is diffused into the material through the mask patterns and front and backside metals are evaporated on the wafer for electrical contact.

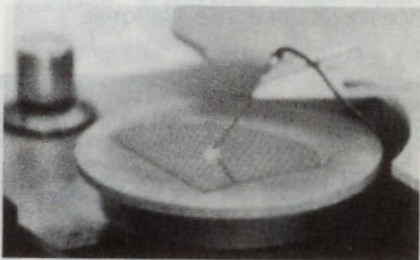

Finished wafers are shipped to one of Litronix' offshore production plants for scribing and breaking into individual LED chips (sometimes known as die) for assembly into finished products.

INTEGRATED CIRCUIT PRODUCTION

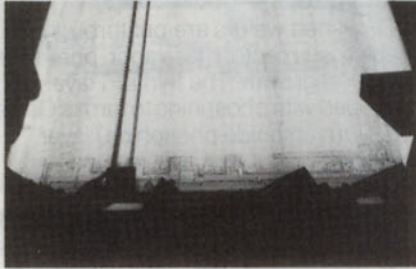

CMOS, NMOS and PMOS LSI (large scale integration) circuits and bi-polar circuits are designed for a wide variety of applications.



Litronix produces silicon integrated circuits at a wafer fabrication facility located in Sunnyvale, California.



Oxidation of silicon wafers in a furnace.



Diffusion: (thermally adding dopant).



Masking for circuit patterns, typically 8 masks per wafer.



Aligning, developing and etching to reproduce the circuit pattern in the oxide mask.

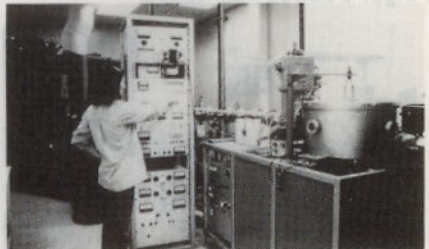

Implanting with dopant atoms in ION implanter (alternate process to thermal diffusion).

MANUFACTURING

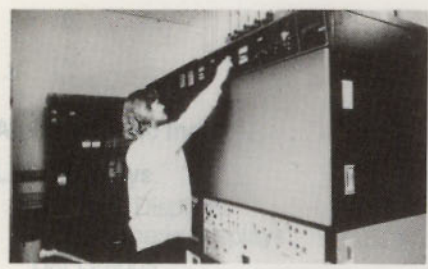

Polysilicon deposition (for silicon gate processing).

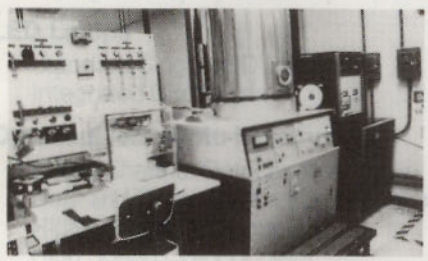

Aluminum deposition to form electrical inter-connect patterns.



Finished wafers are tested on Litronix designed and built micro processor controlled automatic testers.



Litronix Penang, Malaysia plant.

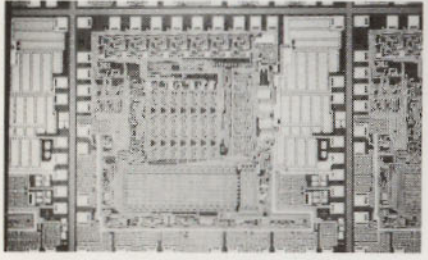

A typical LSI timekeeping circuit.

TABLE OF CONTENTS

Alphanumeric Index	11
LED Displays	
Numeric Displays	15
Alphanumeric Displays	21
Bar Graphs	23
LED Intelligent Displays™	
Four Character Modules	27-46
Intelligent Display Assembly™	47
LED Lamps	
Standard Single LED Lamps	53-74
Integrated Circuit Lamps	75-84
Optocouplers (Opto-Isolators)	
Single Channel Optocouplers	87-112
Dual and Quad Channel Optocouplers	87- 95-119
High Voltage Optocouplers	99
High Speed Optocouplers	113-118
Application Notes	123-160
Reliability Information	161-162

ALPHANUMERIC INDEX

Part Number	Description	Page	Part Number	Description	Page
4N25	Isolator, Sngl., 20% Ctr., 2500V	101	ILA 30	Isolator, Sngl., 100% Ctr, 1500 VD C	105
4N26	Isolator, Sngl., 20% Ctr, 1500V	101	ILA 55	Isolator, Sngl., 100% Ctr, 1500 VD C	105
4N27	Isolator, Sngl., 10% Ctr. 1500V	101	ILCA2-30	Isolator, Sngl., 100% Ctr, 1500 VD C	107
4N28	Isolator, Sngl., 10% Ctr. 500V	101	ILCA2-55	Isolator, Sngl., 100% Ctr, 1500 VD C	107
4N32	Isolator, Sngl., 500%, 2500V	104			
4N33	Isolator, Sngl., 500% Ctr, 1500V	104	ILCT6	Isolator, Dual, 20% Ctr, 1500 V	119
4N35	Isolator, Sngl., 100% Ctr, 3550V	103	ILD-1	Isolator, Dual, 20% Ctr, 2500 V	87
4N36	Isolator, Sngl., 100% Ctr. 2500V	103	ILD74	Isolator, Dual, 12.5% Ctr, 1500 V	95
4N37	Isolator, Sngl., 100% Ctr. 1500V	103			
DL-330M	Display, Red, .11" C.C., MPX, 3 Digit	19	ILQ-1	Isolator, Quad, 20% Ctr, 2500 V	87
DL-340M	Display, Red, .11" C.C., MPX, 4 Digit	19	ILQ74	Isolator, Quad, 12.5% Ctr, 1500 V	95
DL-430M	Display, Red, .15" C.C. MPX, 3 Digit	19	OBG-1000	Display, Orange, 10 Element Bar Graph	23
DL-440M	Display, Red, .15" C.C. MPX, 2 Digit	19	RBG-1000	Display, Red, 10 Element Bar Graph	23
DL-1414	Display, Red, .112", Intelligent, 4 Digit	27			
DL-1416	Display, Red, .160", Intelligent 4 Digit	31	RL-50	Lamp, Red, Sub. Min. Water, Clear	69
DL-2416	Display, Red, .160" Intelligent, 4 Digit	35	RL-50-01	Lamp, Red, Sub. Min. Red, Diffused	69
			RL-50-02	Lamp, Red, Sub. Min. Red, Clear	69
DL-2416H	Red, .160", Intelligent, 4 Digit	35	RL-54	Lamp, Red, Sub. Min. .2 mcd	71
DL-3416	Display, Red, .225", Intelligent, 4 Digit	39	RL-55	Lamp, Red, Sub. Min. 2.0 mcd, 20 mA	72
DL-3416H	Display, Red, .225", Intelligent, 4 Digit	39	RL-55-5	Lamp, Red, Sub. Min. 0.8 mcd, 20 mA	72
DL-3422	Display, Red, 22 SEG. Intelligent, 4 Digit	43			
			RL-209A	Lamp, Red, T1, .050" Leads, .5 mcd	63
DL-3400	Display, Red, .80" C.A., D.P. Left	17	RL-209-1	Lamp, Red, T1, .050" Leads, 1.0 mcd	63
DL-3401	Display, Red, .80" C.A., D.P. Right	17	RL-209-2	Lamp, Red, T1, .050" Leads, 2.0 mcd	63
DL-3403	Display, Red, .80" C.C., D.P. Left	17	RL-2000	Lamp, Red, T1 3/4, 1.6 mcd, 20 mA	53
DL-3405	Display, Red, .80" C.A., D.P. Left	17	RL-4403	Lamp, Red, T1 3/4, 0.8 mcd, 20 mA	53
DL-3406	Display, Red, .80" ± 1 Overflow	17	RL-4484	Lamp, Red, T1 0.8 mcd, 20 mA	63 53
			RL-4850	Lamp, Red, T1 3/4, No Min mcd	61
DL-4770	Display, Red, 27" C.C. MPX, 4 Digit	15	RL-5053-1	Lamp, Red, T1 3/4, 1.0 mcd, 20 mA	55
			RL-5053-2	Lamp, Red, T1 3/4, 1.6 mcd, 20 mA	55
DL-5735	Display, Red, 69" 5 x 7 Dot Matrix	21	RL-5053-3	Lamp, Red, T1 3/4, 2.5 mcd, 20mA	55
			RL-5053A	Lamp, Red, T1 3/4, 0.3 mcd, 20 mA	55
DLO-3900	Display, Hi. Eff. Red, .8" C.A., D.P. Left	17	RL-5054-1	Lamp, Red, T1 3/4, 1.0 mcd, 10mA	57
DLO-3901	Display, Hi. Eff. Red, .8" C.A., D.P. Right	17	RL-5054-2	Lamp, Red, T1 3/4, 2.0 mcd, 10mA	57
DLO-3903	Display, Hi. Eff. Red, .8" C.C., D.P. Right	17			
DLO-3905	Display, Hi. Eff. Red, .8" C.C., D.P. Left	17	RLC-200	Lamp, Red, T1 3/4, Constant Current 20 mA	79
DLO-3906	Display, Hi. Eff. Red, .8" Univ. ± 1 Overflow	17	RLC-201	Lamp, Red, T1 3/4, Constant Current 10 mA	81
			RLC-210	Lamp, Red, T1, Constant Current 10 mA	83
DLO-4770	Display, Hi. Eff. Red, .27" C.C. MPX 4 Digit	15	YBG-1000	Display, Yellow, 10 Element Bar Graph	23
FRL-2000	Lamp, Red, T1 3/4, Flashing	75			
FRL-4403	Lamp, Red, T1 3/4, Flashing	77	YL-56	Lamp, Yellow, Sub Min. Axial	74
			YL-212	Lamp, Yellow, T1, 1.0 mcd, 10 mA	65
GBG-1000	Display, Green, 10 Element Bar Graph	23	YL-4484	Lamp, Yellow, T1, No. Min. mcd	65
			YL-4550	Lamp, Yellow, T1 3/4, 1.0 mcd, 10 mA	59
GL-56	Lamp, Green, Min. Axial	74	YL-4850	Lamp, Yellow, T1 3/4, No Min. mcd	59
GL-211	Lamp, Green, T1, .8 mcd, 20 mA	67			
GL-4484	Lamp, Green, T1, No Min. mcd	67			
GL-4850	Lamp, Green, T1 3/4, No Min. mcd	61			
GL-4950	Lamp, Green, T1 3/4, 1.0 mcd, 20 mA	61			
H11AA1	Isolator, Sngl., AC Input	109			
IDA-2416-16	Intelligent Display Assembly, 16 Char.	47			
IDA-2416-32	Intelligent Display Assembly, 32 Char.	47			
IL-1	Isolator, Sngl., 20% Dtr, 2500 V	87			
IL-5	Isolator, Sngl., 50% Ctr, 2500 V	91			
IL-12	Isolator, Sngl., 10% Ctr, 1000 V	93			
IL-74	Isolator, Sngl., 12.5% Ctr. 1500 V	95			
IL-100	Isolator, Sngl., Hi-Speed, 65 ns	113			
IL-101	Isolator, Sngl., Hi-Speed, 100 ns	117			
IL-201	Isolator, Sngl., 75% Ctr, 5000 V	99			
IL-202	Isolator, Sngl., 125% Ctr, 5000 V	99			
IL-203	Isolator, Sngl., 225% Ctr, 5000 V	99			
IL-250	Isolator, Bidirectional, 50% CTR, 5000 V	111			

LED NUMERIC DISPLAYS

DL-4770
RED
DLO-4770
HIGH EFFICIENCY RED
7-SEGMENT 4-DIGIT DISPLAY

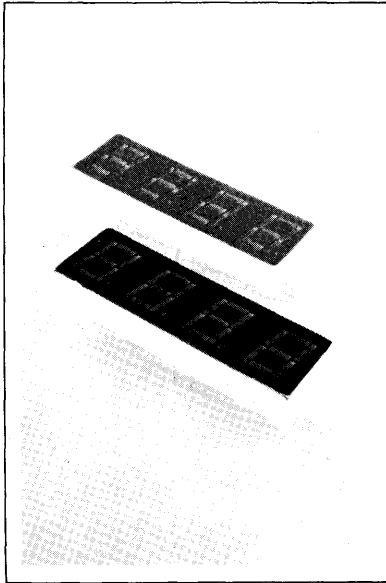

FEATURES

- 0.28 Inch (7 mm) Digit Height
- Rugged Encapsulated Package
- Filled Reflector Construction
- End Stackable Module
- Intensity Coded for Display Uniformity
- Right Hand Decimal
- Colon Included for Clock Applications

DESCRIPTION

The DL-DLO-4770 is a 0.28 inch (7 mm) four-digit display in a 0.39 x 1.26 inch (10 mm x 32 mm) package. The units are end stackable and offer a colon for time-keeping and other operations. The DL/DLO-4770 is designed to serve a wide variety of industrial and consumer applications requiring medium-sized digits in a very small package.

Package Dimensions in Inches (mm)

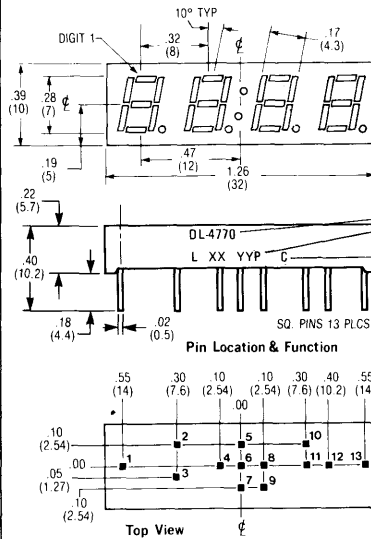

- Pin Location & Function**
- | | | | | | | |
|-----------|-----------|-----------|-----------|-----------|-----------|-----------|
| 55 (14) | 30 (7.6) | 10 (2.54) | 10 (2.54) | 30 (7.6) | 40 (10.2) | 55 (14) |
| 1 | 2 | 5 | 10 | 11 | 12 | 13 |
| 10 (2.54) | 05 (1.27) | 00 (0.00) | 00 (0.00) | 00 (0.00) | 00 (0.00) | 00 (0.00) |
- Pin Function**
- 1 Digit 1 Cathode
 - 2 Segment B Anode
 - 3 Segment C Anode
 - 4 Digit 2 and Lower Colon Cathode
 - 5 Segment A Anode
 - 6 Segment D Anode
 - 7 Decimal Point Anode
 - 8 Digit 3 and Upper Colon Cathode
 - 9 Colon Anode
 - 10 Segment F Anode
 - 11 Segment E Anode
 - 12 Segment G Anode
 - 13 Digit 4 Cathode

Maximum Ratings @ 25°C

Power Dissipation (package)	820 mW
Derate Linearly from 25°C	-13.7 mW/°C
Storage Temperature	-20°C to +85°C
Operating Temperature	-20°C to +85°C
Continuous Forward Current	
DL-4770 (per segment)	30 mA
DL-4770 (all segments lit)	12 mA/seg
DLO-4770 (per segment)	25 mA
DLO-4770 (all segments lit)	10 mA/seg
Peak Inverse Voltage	
DL-4770	3 V
DLO-4770	3 V

Opto-Electronic Characteristics Per Segment (@ 25°C)

Parameter	Min	Typ	Max	Unit	Test Condition
Luminous Intensity/Segment (Digit Average)					
DL	.08	.18		mcd	I _F = 10 mA
DLO	.25	.40		mcd	I _F = 10 mA
Forward Voltage					
DL		2.0		V	I _F = 20 mA
DLO		2.8		V	I _F = 20 mA
Reverse Current					
DL		100		μA	V _R = 3 V
DLO		100		μA	V _R = 3 V
Peak Emission Wavelength					
DL		660		nm	
DLO		630		nm	

Specifications subject to change without notice.

DL-3400 SERIES
RED

DLO-3900 SERIES
HIGH EFFICIENCY RED

0.8 INCH SEVEN SEGMENT NUMERIC DISPLAY

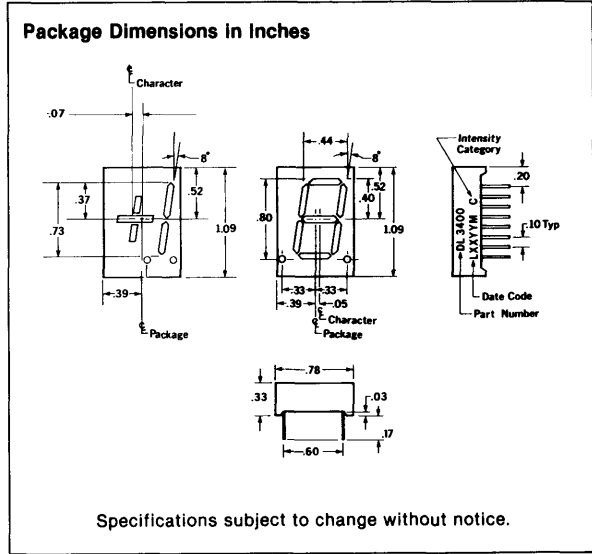
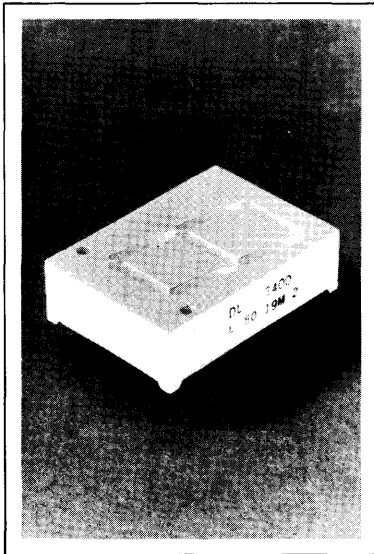

FEATURES

- Rugged Encapsulated Package
- Filled Reflector Construction
- Very Large 0.8 Inch (20 mm) Digit Height
- Choice of: Common Anode or Common Cathode
Left or Right Decimal Point
Universal Polarity Overflow
- Wide Viewing Angle
- Good "Off" Segment Contrast
- Intensity Coded for Display Uniformity
- Standard 0.6 inch Dual-In-Line Package
with Leads on 0.1 inch Centers

DESCRIPTION

The DL-3400 Series, Red, and DLO-3900 Series, High Efficiency Red, are very large 0.8 inch (20 mm) LED seven segment displays. The series offers the choice of either common anode or common cathode versions, left or right decimal point, as well as a polarity and overflow indicator.

These displays were designed for viewing distances of up to 30 feet and can be used in electronic instruments, point-of-sale systems, clocks, and other general industrial and consumer applications.

These displays are painted to match the appearance of an unlit segment in order to maximize contrast enhancement. Contrast enhancement filters are recommended for use with all displays.

Part Number	Description	
DL-3400	Common Anode	Left Hand Decimal
DL-3401	Common Anode	Right Hand Decimal
DL-3403	Common Cathode	Right Hand Decimal
DL-3405	Common Cathode	Left Hand Decimal
DL-3406	Universal Overflow ± 1	Right Hand Decimal
DLO-3900	Common Anode	Left Hand Decimal
DLO-3901	Common Anode	Right Hand Decimal
DLO-3903	Common Cathode	Right Hand Decimal
DLO-3905	Common Cathode	Left Hand Decimal
DLO-3906	Universal Overflow ± 1	Right Hand Decimal

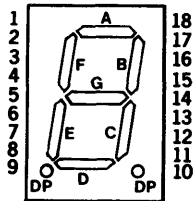

TOP VIEW

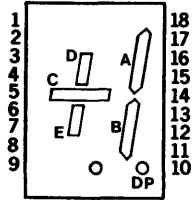

TOP VIEW

PIN	FUNCTION					PIN
	-3900 -3400	-3901 -3401	-3903 -3403	-3905 -3405	-3906 -3406	
1	NO PIN	NO PIN	NO PIN	NO PIN	NO PIN	1
2	CATHODE A	CATHODE A	ANODE A	ANODE A	CATHODE A	2
3	CATHODE F	CATHODE F	ANODE F	ANODE F	CATHODE D	3
4	ANODE	ANODE	CATHODE	CATHODE	CATHODE D	4
5	CATHODE E	CATHODE E	ANODE E	ANODE E	CATHODE C	5
6	ANODE	ANODE	CATHODE	CATHODE	CATHODE E	6
7	CATHODE DP	NO CONN.	NO CONN.	ANODE DP	ANODE E	7
8	NO PIN	NO PIN	NO PIN	NO PIN	CATHODE DP	8
9	NO PIN	NO PIN	NO PIN	NO PIN	NO PIN	9
10	NO PIN	CATHODE DP	ANODE DP	NO PIN	ANODE DP	10
11	CATHODE D	CATHODE D	ANODE D	ANODE D	CATHODE DP	11
12	ANODE	ANODE	CATHODE	CATHODE	CATHODE B	12
13	CATHODE C	CATHODE C	ANODE C	ANODE C	ANODE B	13
14	CATHODE G	CATHODE G	ANODE G	ANODE G	ANODE C	14
15	CATHODE B	CATHODE B	ANODE B	ANODE B	ANODE A	15
16	NO PIN	NO PIN	NO PIN	NO PIN	NO PIN	16
17	ANODE	ANODE	CATHODE	CATHODE	CATHODE A	17
18	NO PIN	NO PIN	NO PIN	NO PIN	NO PIN	18

MAXIMUM RATINGS

	DL-3400 Series	DLO-3900 Series
Power Dissipation per Segment on D _p (T _A = 50 °C)	100mW	85mW
Operating Temperature	-20 °C to +85 °C	-20 °C to +85 °C
Storage Temperature	-20 °C to +85 °C	-20 °C to +85 °C
Peak Forward Current per Segment or D _p (T _A = 50 °C, Pulse Width < 1.2ms)	200mA	120mA
DC Forward Current per Segment or D _p	50mA	30mA
Derating Factor from 50 °C	1mA/°C	.6mA/°C
Reverse Voltage per Segment or D _p	6.0V	6.0V
Lead Soldering Temperature (1/16 inch Below Seating Place)	260 °C for 3 sec.	260 °C for 3 sec.

OPTO-ELECTRICAL CHARACTERISTICS @ T_A = 25 °C

Parameter	Test Condition	Min.	Typ.	Max.	Units
Luminous Intensity/Segment (Digit Average)					
DL-3400 Series	I _F = 20mA	500	900		μcd
DLO-3900 Series	I _F = 20mA	650	2000		μcd
Forward Voltage					
DL-3400 Series	I _F = 20mA		1.6	2.0	V
DLO-3900 Series	I _F = 20mA		2.2	2.8	V
Reverse Current					
DL-3400 Series	V _R = 5V		10	100	μA
DLO-3900 Series	V _R = 6V		10	100	μA
Dominant Wavelength					
DL-3400 Series	λ _d		640		nm
DLO-3900 Series	λ _d		625		nm
Rise and Fall Time			10		ns
Temperature Coefficient of Forward Voltage	I _F = 20mA		-1.5		mV/°C

DL-330M
.11 INCH 3 DIGIT
DL-430M
.15 INCH 3 DIGIT

DL-340M
.11 INCH 4 DIGIT
DL-440M
.15 INCH 2 DIGIT

RED 7 SEGMENT MAGNIFIED MONOLITHIC NUMERIC DISPLAY

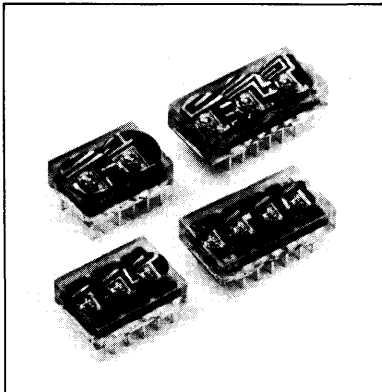

FEATURES

- Rugged Encapsulated Package
- Integrated Magnifier Lens
- Monolithic Construction for Maximum Brightness at Minimum Power
- Common Cathode for Simplicity of Multiplexing
- Standard Dual-In-Line Package
- Categorized for Brightness Uniformity

DESCRIPTION

The DL-330M/340M and DL-430M/440M are red numeric LED displays. Low cost is achieved through minimum use of monolithic GaAsP material and magnification to full height using a simple integrated lens construction. A red plexiglass or circularly polarized filter is recommended to enhance visibility and to eliminate glare from the surface of the package.

These displays are designed for multiplex operation, the desired digit being displayed by selecting the appropriate cathode. A right hand decimal point is provided.

All devices are optimized for low power portable battery operated equipment using MOS and CMOS integrated logic circuits such as DMM's and digital thermometers.

Package Dimensions in Inches

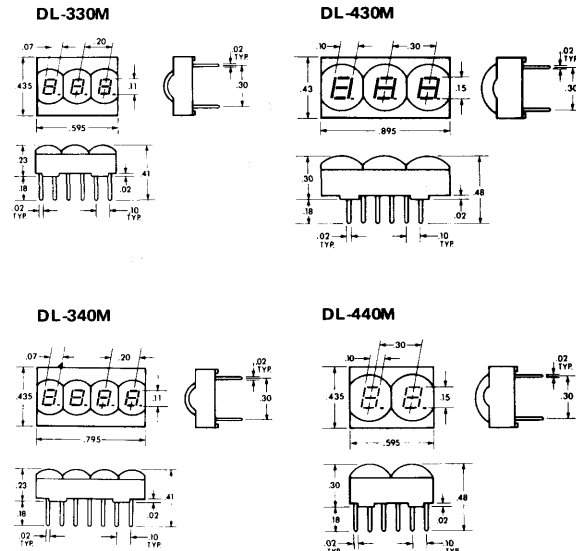

Maximum Ratings (at 25 °C)

Power Dissipation/Digit	80 mW
Derating Factor from 25 °C/Digit	1.8 mW/°C
Storage and Operating Temperature	-20 °C to +70 °C
Continuous Forward Current	
Per Segment and Decimal	20 mA
Per Digit Total	40 mA
Peak Inverse Voltage	
Per Segment and Decimal	3 V

Opto-Electronic Characteristics (at 25 °C)

Parameter	Min	Max	Unit	Test Condition
Luminance	1.5		mcd	I _F = 5 mA
Emission Peak Wavelength	650		nm	
Line Half-Width	40		nm	
Forward Voltage	1.7	2.0		I _F = 20 mA
Dynamic Resistance	7		Ω	I _F = 10 mA
Capacitance	50		pF	V = 0, f = 1 MHz
Reverse Leakage		100	μA	V _R = 3.0 V

Specifications subject to change without notice.

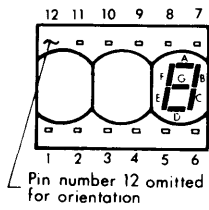

DL-330M	Pin	Function
	1	Cathode D1
	2	Anode E
	3	Anode D
	4	Cathode D2
	5	Anode C
	6	Anode DP
	7	Cathode D3
	8	Anode B
	9	Anode G
	10	Anode A
	11	Anode F
	12	No Pin

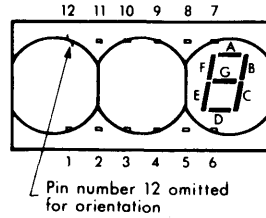

DL-430M	Pin	Function
	1	Cathode D1
	2	Anode E
	3	Anode D
	4	Cathode D2
	5	Anode C
	6	Anode DP
	7	Cathode D3
	8	Anode B
	9	Anode G
	10	Anode A
	11	Anode F
	12	No Pin

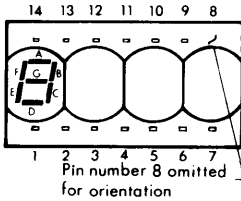

DL-340M	Pin	Function
	1	No Connection
	2	Anode E
	3	Anode D
	4	Anode C
	5	Anode DP
	6	Anode G
	7	Cathode 4
	8	No Pin
	9	Anode B
	10	Cathode 3
	11	Anode F
	12	Cathode 2
	13	Anode A
	14	Cathode 1

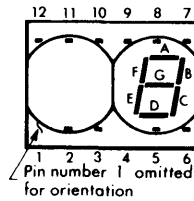

DL-440M	Pin	Function
	1	No Pin
	2	Anode E
	3	Anode D
	4	No Pin
	5	Anode C
	6	Anode DP
	7	Cathode D2
	8	Anode B
	9	Anode G
	10	Anode A
	11	Anode F
	12	Cathode D1

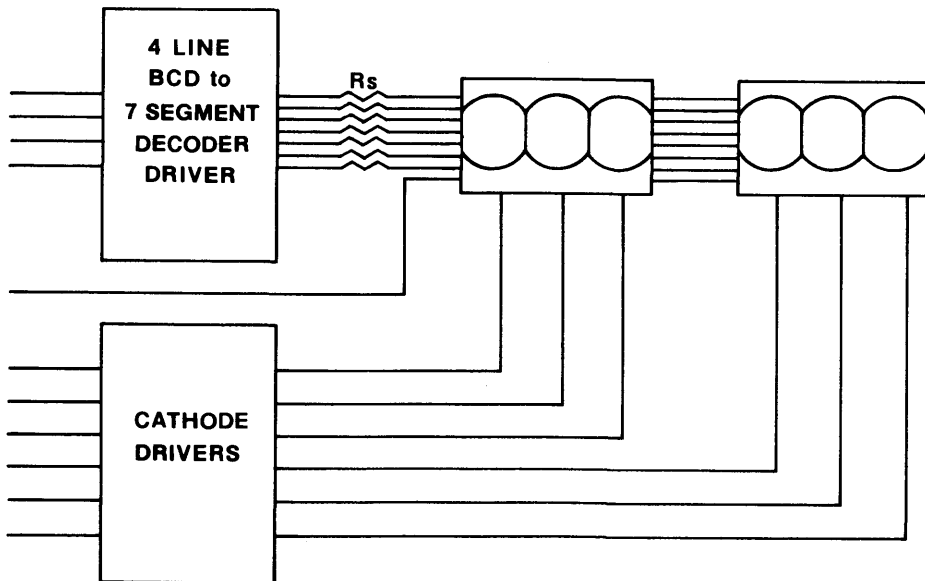

BLOCK DIAGRAM FOR TYPICAL DISPLAY DRIVE CIRCUITRY

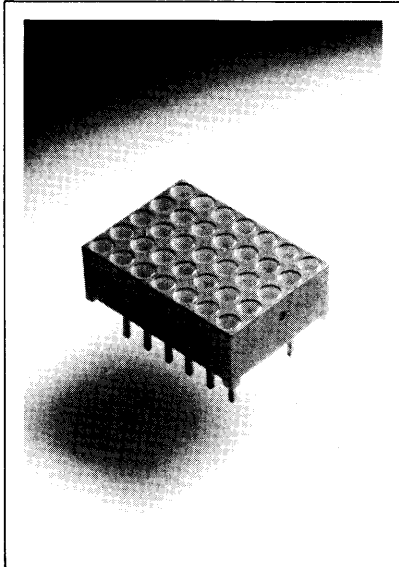

FEATURES

- 5x7 Matrix Array with Row-column Select
- End & Side Stackable
- Rugged Encapsulation (Filled Reflector Construction)
- Compatible with ASCII and EBCDIC Format
- Standard 12 pin, 0.3" pin spacing, Dual-In-line-Package
- Good "OFF" Segment Contrast
- Grey face with clear segments.

DESCRIPTION

The DL5735 is a 5x7 dot matrix gallium arsenide phosphide light emitting diode alphanumeric display.

Compatible with ASCII and EBCDIC formats, the DL5735 is well suited for use in keyboard verifiers, computer peripheral equipment, other applications requiring an alphanumeric display, and stackable both horizontally and vertically to generate large alphanumeric or even graphic displays.

Package Dimensions in Inches (mm)

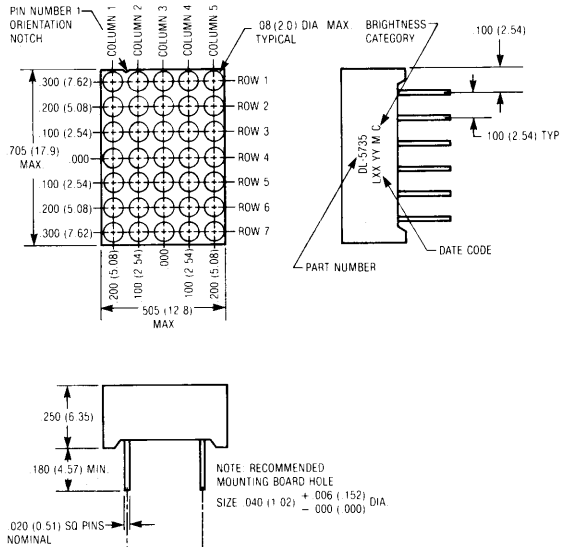

Maximum Ratings @ 25°C

Power Dissipation/Package750 mW
Derate Linearly from 25°C	11.5 mW/°C
Storage Temperature	-20 to +70°C
Operating Temperature	-20 to +70°C
Continuous Forward Current		
Per Segment20 mA
Pulse Peak Current/Segment		
20% Duty Cycle	100 mA
Reverse Voltage3V
Solder Temperature		
1/16 below seating plane for 5 seconds	260°C

Opto-Electronics Characteristics @ 25°C

Parameter	Min	Typ	Max	Unit	Test Conditions
Luminous Intensity					
Per DOT					
Digit Average	100	200		μcd	I _F = 20 mA
Forward Voltage		1.7	2.0	V	I _F = 20 mA
Reverse Current			100	μA	V _R = 3 V
Peak Emission Wavelength		650		nm	
Spectral Line Half-Width		40		nm	
Capacitance		115		pf	V = 0

Specifications subject to change without notice.

PIN CONFIGURATIONS

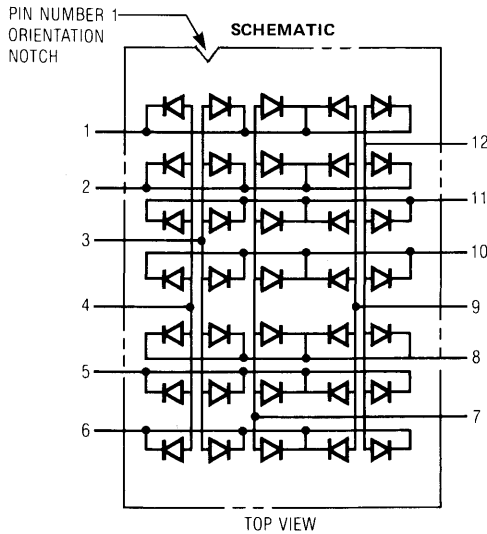

PIN FUNCTION

PIN	FUNCTION
1	ROW 1 CATHODE
2	ROW 2 CATHODE
3	COLUMN 2 ANODE
4	COLUMN 1 ANODE
5	ROW 6 CATHODE
6	ROW 7 CATHODE
7	COLUMN 3 ANODE
8	ROW 5 CATHODE
9	COLUMN 4 ANODE
10	ROW 4 CATHODE
11	ROW 3 CATHODE
12	COLUMN 5 ANODE

TYPICAL VERTICAL SCAN DISPLAY SYSTEM

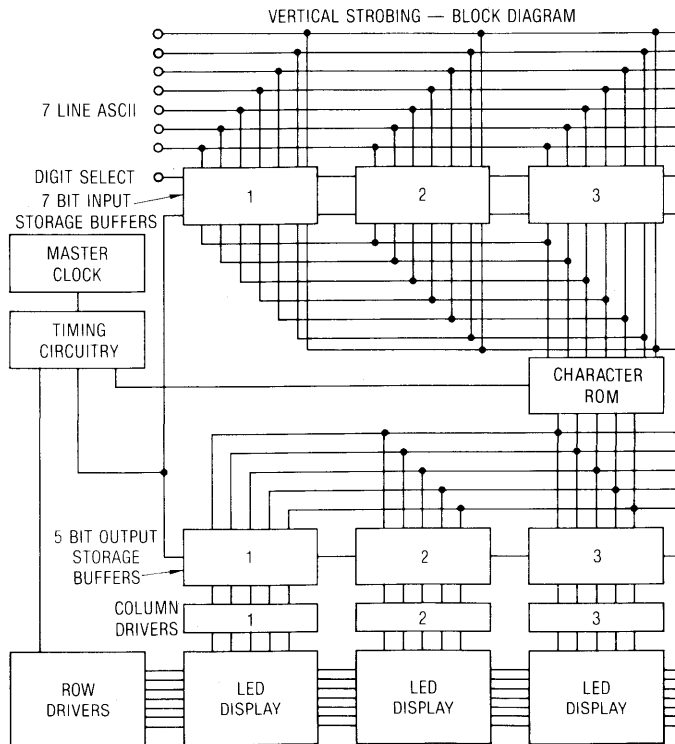

RBG-1000
RED
YBG-1000
YELLOW

OBG-1000
HIGH EFFICIENCY RED
GBG-1000
GREEN

10 ELEMENT LINEAR DISPLAY

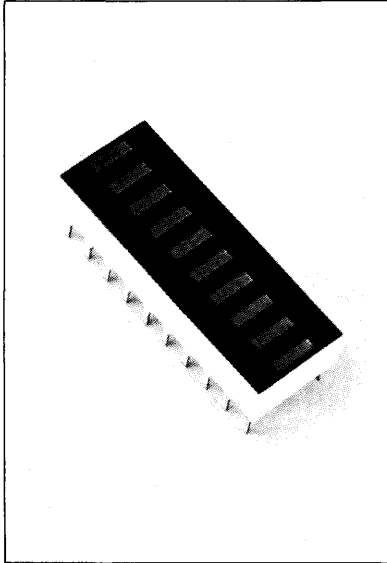

FEATURES

- 10 Element Display
- End Stackable Module
- Individual Addressable Anode and Cathode
- Intensity Coded for Display Uniformity
- Rugged Encapsulation
- Choice of Colors

DESCRIPTION

The Red RBG-1000, Hi-efficiency Red OBG-1000, Yellow YBG-1000, and Green GBG-1000 are 10 individual element linear bar displays. They are contained in a 1 inch long, 20 pin dual-in-line package that can be end stacked as bar-graph displays of various lengths. Applications include: bar graph, solid-state meter movement, position indicator, etc.

Package Dimensions in Inches

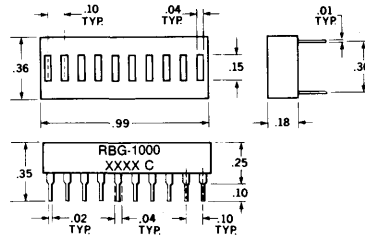

Maximum Ratings

Storage Temperature	-20° to +85°C
Operating Temperature	20° to +85°C
Power Dissipation @25°C	450 mW
Derating Factor from 25°C	7.5 mW/°C
Continous Forward Current	
RBG-1000 per display	200 mA
per element	20 mA
OBG-1000	
YBG-1000 per display	156 mA
GBG-1000 per element	20 mA
Peak Inverse Voltage per Element	3 V

Opto-Electronic Characteristics (@25°C)

Parameter	Typ	Max	Unit	Test Condition	
Luminous Intensity/ Element (Display Average)					
RBG-1000	.5		mcd	$I_F = 20 \text{ mA/}$	Segment
OBG-1000	2.5		mcd	$I_F = 20 \text{ mA/}$	Segment
YBG-1000	2.0		mcd	$I_F = 20 \text{ mA/}$	Segment
GBG-1000	2.0		mcd	$I_F = 20 \text{ mA/}$	Segment
Forward Voltage					
RBG-1000	1.7	2.0	V	$I_F = 20 \text{ mA}$	
OBG-1000	2.2	2.8	V	$I_F = 20 \text{ mA}$	
YBG-1000	2.4	3.0	V	$I_F = 20 \text{ mA}$	
GBG-1000	2.4	3.0	V	$I_F = 20 \text{ mA}$	
Reverse Leakage	0.1	100	μA	$V_R = 3 \text{ V}$	
Emission Peak Wavelength					
RBG-1000		660	nm		
OBG-1000		630	nm		
YBG-1000		585	nm		
GBG-1000		565	nm		

Specifications subject to change without notice.

RBG-1000, OBG-1000, YBG-1000 AND GBG-1000

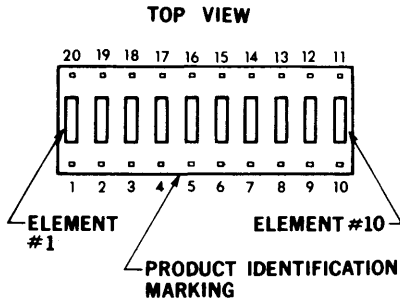

PIN	FUNCTION	PIN	FUNCTION
1	ANODE 1	11	CATHODE 10
2	ANODE 2	12	CATHODE 9
3	ANODE 3	13	CATHODE 8
4	ANODE 4	14	CATHODE 7
5	ANODE 5	15	CATHODE 6
6	ANODE 6	16	CATHODE 5
7	ANODE 7	17	CATHODE 4
8	ANODE 8	18	CATHODE 3
9	ANODE 9	19	CATHODE 2
10	ANODE 10	20	CATHODE 1

TYPICAL APPLICATIONS

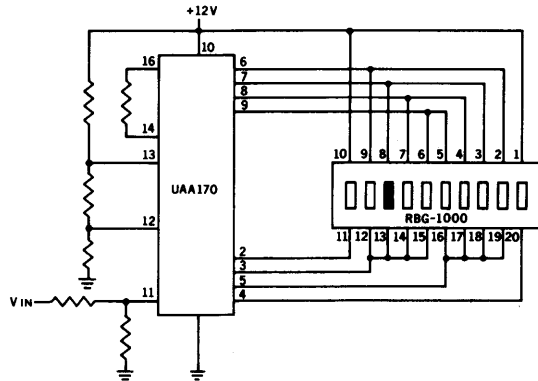

LIGHT SPOT DISPLAY

LINEAR DISPLAY DRIVERS

Siemens UAA170
Siemens UAA180
National LM3914
National LM3915
Sharp IR2406

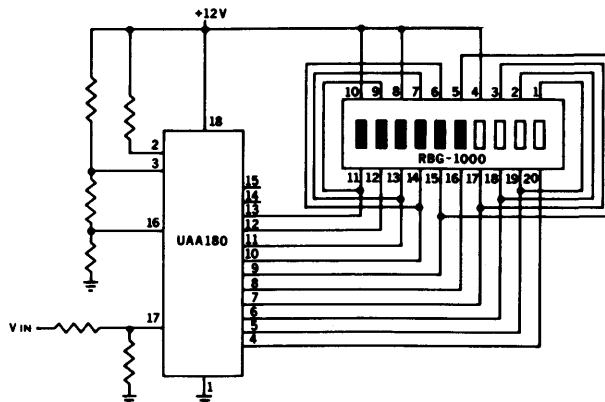

LIGHT BAND DISPLAY

No endorsement or warranty of other manufacturer's products is intended by Litronix

LED Intelligent Displays™

DL-1414

.112" RED, 4-DIGIT 17-SEGMENT ALPHANUMERIC Intelligent Display™ WITH MEMORY/DECODER/DRIVER

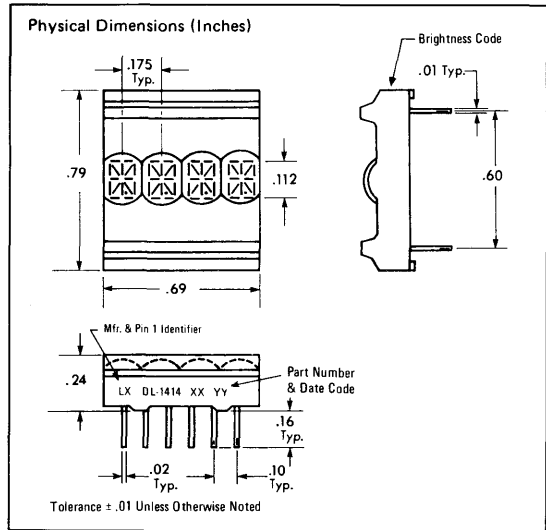
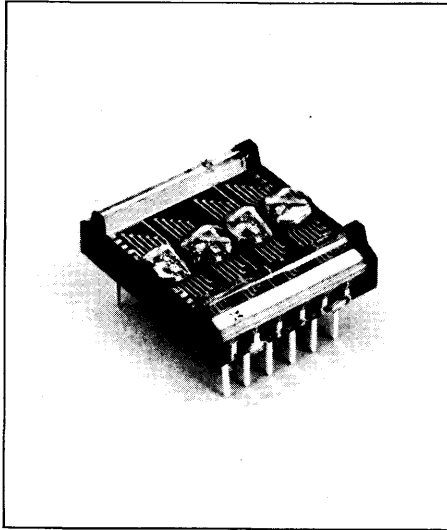

FEATURES

- 112 Mil High, Magnified Monolithic Char.
- Wide Viewing Angle, $\pm 40^\circ$
- Close Vertical Row Spacing, .800 Inches
- Rugged Solid Plastic Encapsulated Package
- Fast Access Time, 450 nSEC
- Compact Size For Hand Held Equipment
- Built-In Memory
- Built-In Character Generator
- Built-In Multiplex and LED Drive Circuitry
- Direct Access To Each Digit Independently and Asynchronously
- TTL Compatible, 5 Volt Power
- 17th Segment For Improved Punctuation Marks
- Low Power Consumption, Typically 10 mA per character
- Intensity Coded For Display Uniformity
- End-Stackable, 4-Character Package

DESCRIPTION

The DL1414 is a four digit display module having 16 bar segments plus a decimal segment and a built-in CMOS integrated circuit.

The integrated circuit contains memory, ASCII character generator, and LED multiplexing and drive circuitry.

Inputs are TTL compatible. A single 5-volt power supply is required. Data entry is asynchronous and random access. A display system can be built using any number of DL1414's since each character in any DL1414 can be addressed independently and will continue to display the character last written until it is replaced by another.

LOADING DATA

Loading data into the DL1414 is straightforward. The desired data code (D_0-D_6) and digit address (A_0, A_1) is presented in parallel and held stable during a write cycle. Data entry may be asynchronous and in random order. (Digit 0 is defined as right hand digit with $A_1 = A_0 = 0 = \text{low}$).

System interconnection is also straightforward. The least significant two address bits (A_0, A_1) are normally connected to the like named inputs of all DL1414's in the system. Data lines are connected to all DL1414's directly and in parallel. Multiple DL1414 systems usually use an external one-of-N decoder chip. The "write" pulse is connected to the CE of the decoder. A 3-to-8 line decoder multiplexer (74138) or a 4-to-16 line decoder/multiplexer (74154) are possible choices. All higher-order address bits (above A_1) become inputs to the decoder.

Specifications Subject To Change Without Notice

Pin	Function	Pin	Function
1	D5 Data Input	7	Gnd
2	D4 Data Input	8	D0 Data Input (LSB)
3	WR Write	9	D1 Data Input
4	A1 Digit Select	10	D2 Data Input
5	A0 Digit Select	11	D3 Data Input
6	V _{CC}	12	D6 Data Input (MSB)

TOP VIEW

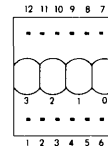

Product Identification Markings on Front Surface

OPTO-ELECTRONIC CHARACTERISTICS @ 25°C

MAXIMUM RATINGS	
Voltage, Any Pin	-.5 to +6 VDC
Respect to GND	-.5 to +6 VDC
Operating Temperature	-20°C to 65°C
Storage Temperature	-20°C to 70°C
Relative Humidity (non condensing)	@ 65°C, 85%

OPTICAL CHARACTERISTICS (TYPICAL)	
Luminous Intensity per digit/8 segments @ 5V	0.5 mcd
Off Axis Viewing Angle (Note 1)	±40°
Digit Size	112 mils
Spectral Peak Wavelength	660 nm

DC CHARACTERISTICS

Parameter	-20°C Typ	+25°C (Note 6)	+65°C Typ	Conditions
I _{CC} 4 Digits on (10 seg/Digit)	100 mA	90 mA Max	70 mA	V _{CC} = 5.0 V
I _{CC} Blank		2.7 mA Max		V _{IN} = 0 V _{CC} = 5.0 V WR = 5.0 V
I _{IL}	180 μA	160 μA Max	100 μA	V _{IN} = .8 V V _{CC} = 5.0 V
V _{IL}		.8 V Max		V _{CC} = 4.5 V
V _{IH} (Note 4)		2.7 V Min		V _{CC} = 4.5 V
		3.3 V Min		V _{CC} = 5.5 V

TIMING CHARACTERISTICS

AC CHARACTERISTICS			
MINIMUM TIMING PARAMETERS @ 4.5 V (nanoseconds)			
Parameter	-20°C Typ	25°C Min	+65°C Typ
T _{AS}	300	400	500
T _{WD}	50	75	125
T _W	250	325	375
T _{DS}	200	250	300
T _{DH}	50	50	100
T _{AH}	50	50	100

WRITE CYCLE WAVEFORMS

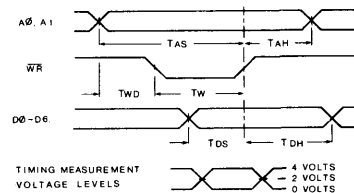

Note 1: "Off Axis Viewing Angle" is here defined as: "the minimum angle in any direction from the normal to the display surface at which any part of any segment in the display is not visible".

Note 2: This display contains a CMOS integrated circuit. Normal CMOS handling precautions should be taken to avoid damage due to high static voltages or electric fields.

Note 3: Unused inputs must be tied to an appropriate logic voltage level (either V+ or V-).

Note 4: V_{CC} ≥ V_{IH} ≥ 0.6 V_{CC}.

Note 5: **Warning** – Do not use solvents containing alcohol.

Note 6: V_{CC} = +5.0 VDC ±10%

CHARACTER SET

	D0	L	H	L	H	L	H	L	H
	D1	L	L	H	H	L	L	H	H
	D2	L	L	L	L	H	H	H	H
D6 D5 D4 D3									
L H L L		!	"	#	\$	%	&	'	
L H L H	<	>	*	+	,	-	.	/	
L H H L	0	1	2	3	4	5	6	7	
L H H H	8	9	:	;	<	=	>	?	
H L L L	@	A	B	C	D	E	F	G	
H L L H	H	I	J	K	L	M	N	O	
H L H L	P	Q	R	S	T	U	V	W	
H L H H	X	Y	Z	[\]	^	_	

All Other Input Codes Display "Blank"

LOADING DATA STATE TABLE

WR		A1	A0	D6	D5	D4	D3	D2	D1	D0	DIGIT			
											3	2	1	0
H				PREVIOUSLY LOADED DISPLAY							G	R	E	Y
L	L	L	H	H	L	L	L	H	L	H	G	R	U	E
L	L	H	L	H	L	L	H	H	L	L	G	L	U	E
L	L	H	H	H	L	L	L	L	H	L	B	L	U	E
L	L	L	H	H	L	L	L	H	L	H	B	L	E	E
L	L	L	L	H	L	H	L	H	H	H	B	L	E	W
L	X	X		SEE CHARACTER CODE							SEE CHARACTER SET			

X = DON'T CARE

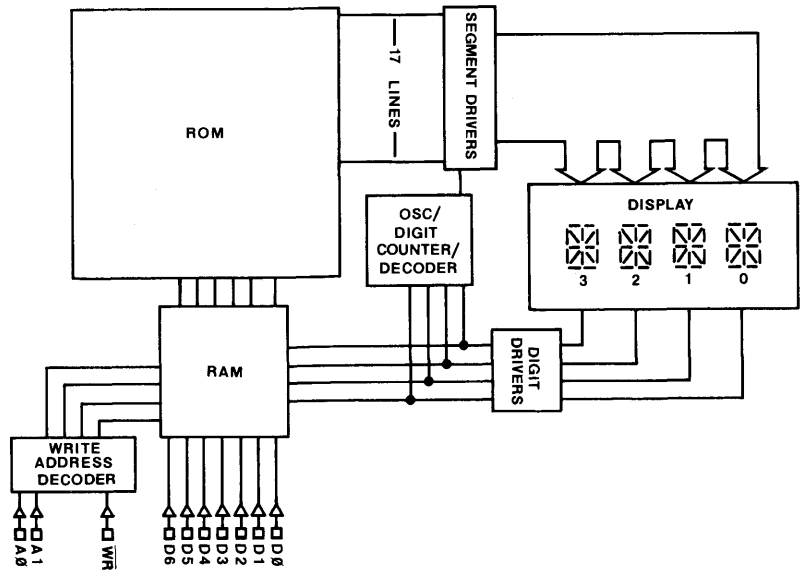

DL-1414 Block Diagram

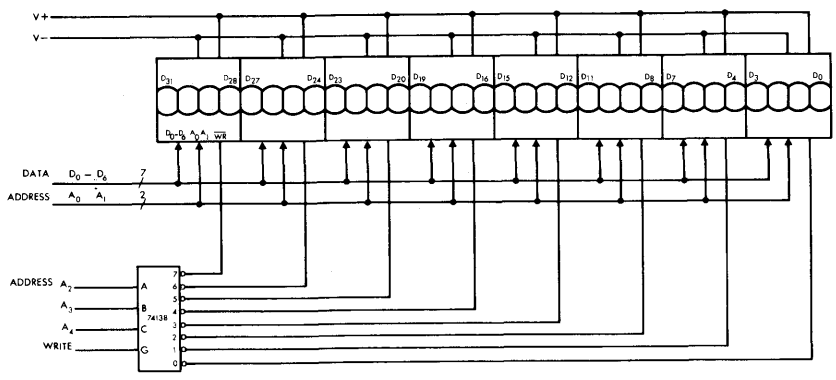

TYPICAL INTERCONNECTION FOR 32 DIGITS

DL-1416

.160" RED, 4-DIGIT 16-SEGMENT
ALPHANUMERIC Intelligent Display™
WITH MEMORY/DECODER/DRIVER

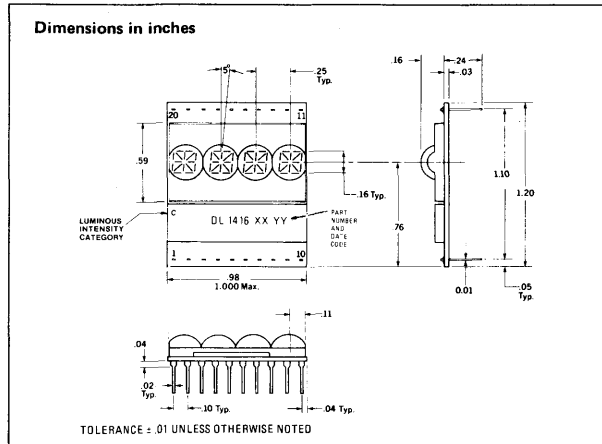
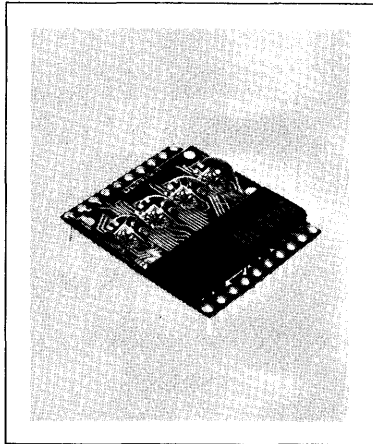

FEATURES

- End-stackable, 4-Character Package
- High Contrast, 160 mil High, Magnified Monolithic Characters
- 64-Character ASCII Format
- Built-in Memory, Decoder, Multiplexer and Drivers
- Direct Access to Each Digit Independently and Asynchronously
- 5 Volt Logic, TTL Compatible
- 5 Volt Power Supply Only
- Independent Cursor Function
- Intensity Coded For Display Uniformity

DESCRIPTION

The DL-1416 Intelligent Display is a four-digit LED display module having a 16-segment font and an on-board CMOS integrated circuit driver.

The CMOS chip includes memory for four digits and cursor, 64 ASCII character generator ROM, and segment/digit drivers with associated multiplexing circuitry. Inputs are TTL compatible as is the power supply requirement. Data entry is asynchronous and

random access. A display system can be built using any number of DL-1416s since each digit of each DL-1416 can be addressed independently. Each digit will continue to display the character last "written" until replaced by another.

A cursor is defined as all segments of a digit position to be lit. The cursor is *not* a character, however, and upon removal leaves the previously displayed character unchanged. Normally, the cursor would be loaded and unloaded (flash) under software control. This can be used as a pointer in a line of DL-1416 displays or a "lamp test" function is realized by simply storing a cursor in all four digit positions of a display.

System interconnection is very straight forward. The least significant two address bits (A_0 , A_1) are connected to the like inputs of all DL-1416s in a system. In small systems having 16 digits (4-DL-1416s), the enable (\overline{CE}) inputs of the four devices could simply be used directly to select each DL-1416. In larger displays, the \overline{CE} inputs would come from a 1-of-N decoder integrated circuit. In this case, address lines $A_2 \dots A_n$ would go to the decoder inputs. Data lines (D_0 - D_6) would be connected to all DL-1416s directly and in parallel. The cursor (\overline{CU}) and write (\overline{W}) lines would also be connected directly and in parallel. The display will then behave as a "write-only memory."

Specifications subject to change without notice.

Pin	Function	Pin	Function
1	D5 Data Input	11	A1 Digit Select
2	D4 Data Input	12	Unused
3	D0 Data Input	13	Unused
4	D1 Data Input	14	Unused
5	D2 Data Input	15	Unused
6	D3 Data Input	16	Unused
7	\overline{CE} Chip Enable	17	Unused
8	\overline{W} Write	18	V+
9	\overline{CU} Cursor Input	19	V-
10	A0 Digit Select	20	D6 Data Input

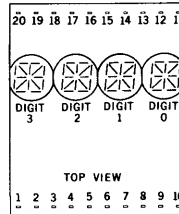

OPTO-ELECTRONIC CHARACTERISTICS @ 25°C

MAXIMUM RATINGS	
Voltage, Any Pin	Respect to GND (V-) . . . -0.5 to V _{CC} +0.5 VDC
Operating Temperature -20 to +65°C
Storage Temperature -20 to +70°C
Relative Humidity	(non condensing) @ 65°C 85%

OPTICAL CHARACTERISTICS (TYPICAL)	
Luminous Intensity per digit/8 segments @ 5V,	0.5 mcd
Viewing Angle	±20°
Digit Size	160 mils
Spectral Peak Wavelength	660 nm

DC CHARACTERISTICS				
Parameter	-20°C Typ	+25°C ⁴	+65°C Typ	Conditions
I _{CC} 4 digits on (10 seg/digit)		75 mA max ¹		V _{CC} = 5.0 V
I _{CC} Cursor ²		100 mA max ¹		V _{CC} = 5.0 V
I _{CC} Blank	5.0 mA	5 mA max	2.0 mA	V _{IN} = 0 V _{CC} = 5.0 V WR = 5.0 V
I _{IL}	20 μA	160 μA max	10 μA	V _{IN} = .8 V V _{CC} = 5.0 V
V _{IL}		.8 V Max		V _{CC} = 4.5 V
V _{IH} ³		2.7 V Min		V _{CC} = 4.5 V
		3.3 V Min		V _{CC} = 5.5 V

1. Measured at 5 seconds.
2. 60 sec. max. duration.
3. V_{CC} ≥ V_{IH} ≥ 0.6 V_{CC}
4. V_{CC} = +5.0 VDC ±10%

AC CHARACTERISTICS @ 25°C	
MINIMUM TIMING PARAMETERS @ 4.5 V (nanoseconds)	
T _{AS}	1000
T _{WD}	500
T _W	500
T _{DS}	1000
T _{DH}	400
T _{TAH}	400
T _{CEH}	400
T _{CES}	1000

TIMING CHARACTERISTICS

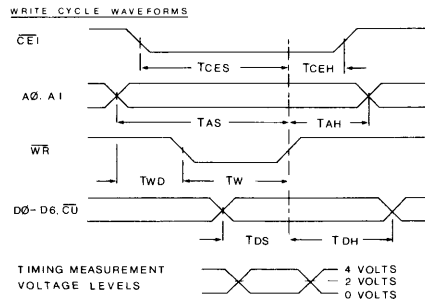

Note 1: This display contains a CMOS integrated circuit. Normal CMOS handling precautions should be taken to avoid damage due to high static voltages or electric fields.

Note 2: Unused inputs must be tied to an appropriate logic voltage level (either V+ or V-).

Note 3: Warning - Do not use solvents containing alcohol.

LOADING DATA

The chip enable (\overline{CE}) held low and cursor (\overline{CU}) held high will enable data loading. The desired data code (D_0 - D_6) and selected digit address (A_0 - A_1) should be held stable while write (\overline{W}) is low for storing new data. The timing parameters in the AC characteristics table are minimum and should be observed. There are no maximum timing requirements. Data entry may be asynchronous and in random order. All undefined data codes (see character set) loaded as data will display a blank.

Digit 0 is defined as the right hand digit with $A_1 = A_0 = 0 = \text{low}$.

LOADING CURSOR

The chip enable (\overline{CE}) and Cursor (\overline{CU}) are held low. A write (\overline{W}) signal will now load a cursor into any digit position for which the respective first four data lines (D_0 , D_1 , D_2 , D_3) individually or together are held high. If previously stored, the cursors can only be removed if their respective data lines are held low while \overline{CE} , \overline{CU} are low and write (\overline{W}) occurs.

The cursor (\overline{CU}) should *not* be hardwired high (off). During the power-up of DL-1416s the cursor memory will be in a random state. Therefore, it is recommended for the processor-based system to initialize or write out possible cursors during the system initializing portion of the software.

The cursor display will be over ridden by a blank from an undefined code in that digit position.

TYPICAL LOADING DATA STATE TABLE

ADDRESS		DATA INPUT								DIGIT					
\overline{CE}	\overline{CU}	\overline{W}	A_1	A_0	D_6	D_5	D_4	D_3	D_2	D_1	D_0	3	2	1	0
H	X	X	X	X	X	X	X	X	X	X	X	NO CHANGE	NO CHANGE	NO CHANGE	NO CHANGE
L	H	L	L	L	H	L	L	L	L	L	H	A	A	A	A
L	H	L	L	H	H	L	L	L	L	H	L	NO CHANGE	NO CHANGE	B	A
L	H	L	H	L	H	L	L	L	L	H	H	NO CHANGE	NO CHANGE	C	B
L	H	L	H	H	H	L	L	L	H	L	L	D	C	B	A
L	H	L	L	L	H	L	L	L	H	L	H	D	C	B	E
L	H	L	H	L	H	L	L	H	L	H	H	D	K	B	E
L	H	L	-	-	-	-	-	-	-	-	-	SEE CHARACTER SET			

X = DON'T CARE

TYPICAL LOADING CURSOR STATE TABLE

ADDRESS		DATA INPUT								DIGIT					
\overline{CE}	\overline{CU}	\overline{W}	A_1	A_0	D_6	D_5	D_4	D_3	D_2	D_1	D_0	3	2	1	0
H	X	X	X	X	X	X	X	X	X	X	X	D	K	B	E
L	L	L	X	X	X	X	X	L	L	L	H	D	K	B	E
L	L	L	X	X	X	X	X	L	L	L	L	D	K	B	E
L	L	L	X	X	X	X	X	L	L	H	L	D	K	B	E
L	L	L	X	X	X	X	X	L	H	L	L	D	B	B	E
L	L	L	X	X	X	X	X	H	L	L	L	B	K	B	E
L	L	L	X	X	X	X	X	H	H	H	H	B	B	B	E
L	L	L	X	X	X	X	X	L	L	L	L	D	K	B	E

X = DON'T CARE

CHARACTER SET

D_0	L	H	L	H	L	H	L	H
D_1	L	L	H	H	L	L	H	H
D_2	L	L	L	L	H	H	H	H
$D_6 D_5 D_4 D_3$								
L H L L	0	1	2	3	4	5	6	7
L H L H	<	>	*	+	,	-	.	/
L H H L	8	9	:	;	<	=	>	?
H L L L	A	B	C	D	E	F	G	
H L L H	H	I	J	K	L	M	N	O
H L H L	P	Q	R	S	T	U	V	W
H L H H	X	Y	Z	[\]	^	_

NOTE: All undefined data codes that are loaded or occur on power-up will cause a blank display state.

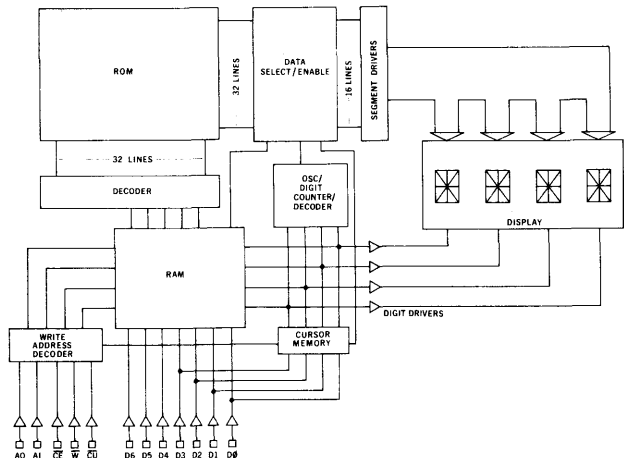

INTERNAL SCHEMATIC

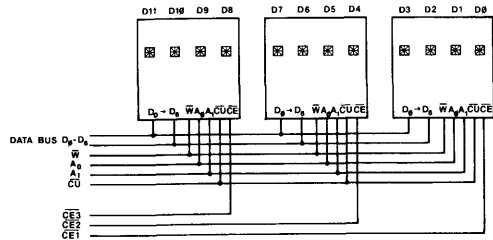

Typical interconnect for small systems, 12 digits

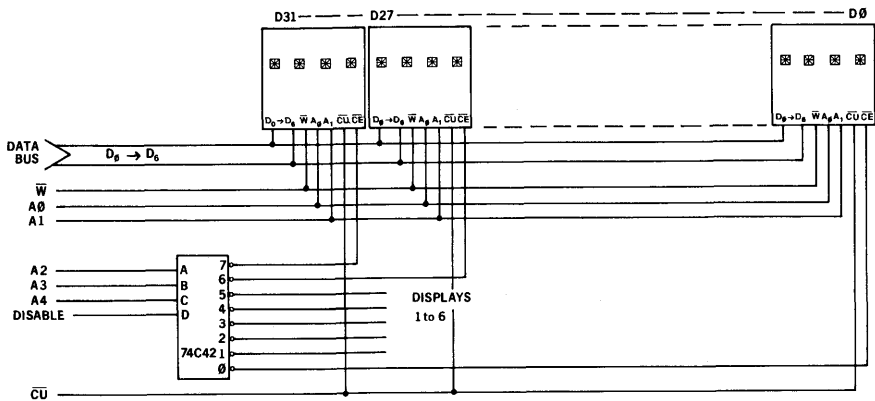

Typical schematic for 32 digit systems

DL-2416, DL-2416 H

.160" RED, 4-DIGIT 16-SEGMENT PLUS DECIMAL
ALPHANUMERIC Intelligent Display™
WITH MEMORY/DECODER/DRIVER

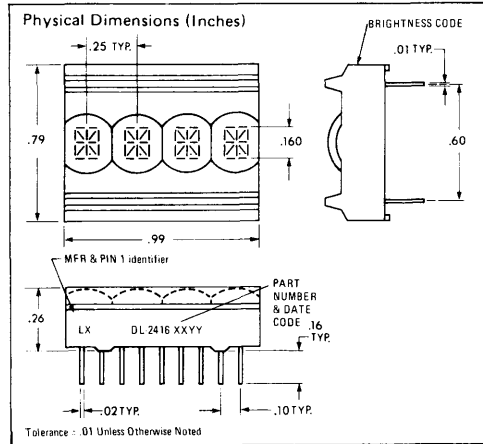
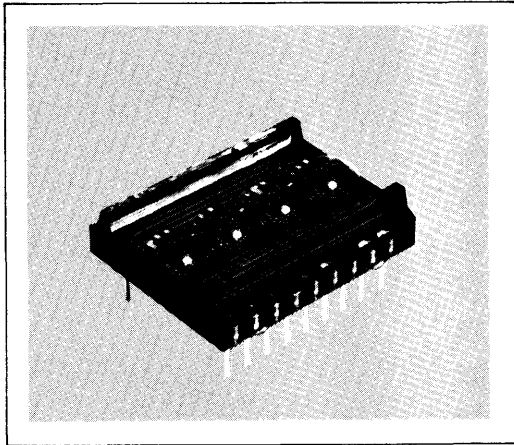

FEATURES

- 160 Mil High, Magnified Monolithic Char.
- Wide Viewing Angle $\pm 50^\circ$
- Close Vertical Row Spacing, .800 Inches
- Rugged Solid Plastic Encapsulated Package
- Fast Access Time
DL-2416 500 nSEC
DL-2416H 300 nSEC
- Full Size Display for Stationary Equipment
- Built-in Memory
- Built-in Character Generator
- Built-in Multiplex and LED Drive Circuitry
- Direct Access to Each Digit Independently & Asynchronously
- TTL Compatible, 5 Volt Power
- Independent Cursor Function
- 17th Segment for Improved Punctuation Marks
- Memory Clear Function
- Display Blank Function
- End-Stackable, 4-Character Package
- Intensity Coded for Display Uniformity

DESCRIPTION

The DL 2416 is a four digit display module having 16 segments plus decimal and a built-in CMOS integrated circuit.

The integrated circuit contains memory, ASCII ROM decoder, multiplexing circuitry, and drivers. Data entry is asynchronous and can be random. A display system can be built using any number of DL 2416's since each digit of any DL 2416 can be addressed independently and will continue to display the character last stored until replaced by another. System interconnection is very straightforward. The least significant two address bits (A_0, A_1) are normally connected to the like named inputs of all DL 2416's in the system. With two chip enables ($\overline{CE1}$, and $\overline{CE2}$) four DL 2416's (16 characters) can easily be interconnected without a decoder.

Alternatively, one-of-n decoder IC's can be used to extend the address for large displays.

Data lines are connected to all DL 2416's directly and in parallel, as is the write line (WR). The display will then behave as a write-only memory.

The cursor function causes all segments of a digit position to illuminate. The cursor is *not* a character, however, and upon removal the previously displayed character will reappear.

Specifications are subject to change without notice.

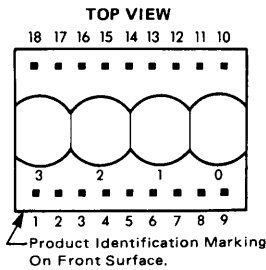

Pin	Function	Pin	Function
1	CE1 Chip Enable	10	Gnd
2	CE2 Chip Enable	11	D0 Data Input
3	CLR Clear	12	D1 Data Input
4	CUE Cursor Enable	13	D2 Data Input
5	CU Cursor Select	14	D3 Data Input
6	WR Write	15	D6 Data Input
7	A1 Digit Select	16	D5 Data Input
8	A0 Digit Select	17	D4 Data Input
9	V _{CC}	18	BL Display Blank

OPTO-ELECTRONIC CHARACTERISTICS @ 25°C

MAXIMUM RATINGS	
Voltage, Any Pin	Respect to GND -5 to 6.0 VDC
Operating Temperature	
Storage Temperature	
Relative Humidity	
(non condensing) @ 65°C	

OPTICAL CHARACTERISTICS (TYPICAL)	
Luminous Intensity per digit/8 segments 0.5 mcd
Off Axis Viewing Angle (Note 1) ±50°
Digit Size 160 mils
Spectral Peak Wavelength 660 nm

DC CHARACTERISTICS				
DL-2416 AND DL-2416 H				
Parameter	-20°C Typ	+25°C ⁴	+65°C Typ	Conditions
I _{CC} 4 digits on (10 seg/digit)	135 mA	125 mA max ¹	100 mA	V _{CC} = 5.0 V
I _{CC} Cursor ²	160 mA	140 mA max ¹	120 mA	V _{CC} = 5.0 V
I _{CC} Blank		3.7 mA max		V _{IN} = 0 V _{CC} = 5.0 V WR = 5.0 V
I _{IL}	200 μA	160 μA max	100 μA	V _{IN} = .8 V V _{CC} = 5.0 V
V _{IL}		.8 V max		V _{CC} = 4.5 V
V _{IH} ³		2.7 V min		V _{CC} = 4.5 V
		3.3 V min		V _{CC} = 5.5 V

1. Measured at 5 sec.
2. 60 sec max duration.
3. V_{CC} ≥ V_{IH} ≥ 0.6 V_{CC}.
4. V_{CC} = +5.0 VDC ±10%

TIMING CHARACTERISTICS

WRITE CYCLE WAVEFORMS

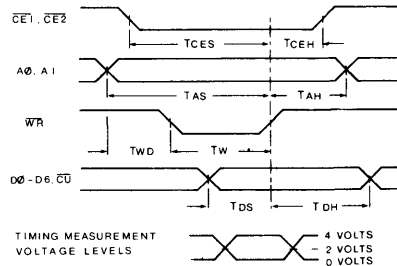

AC CHARACTERISTICS						
Timing Parameters @ 4.5 V (nanoseconds)						
Parameter	-20°C Typ		+25°C Min		+65°C Typ	
	DL-2416	DL-2416 H	DL-2416	DL-2416 H	DL-2416	DL-2416 H
TAS	300	200	450	250	600	400
TWD	50	50	150	50	175	75
TW	250	150	300	200	425	325
TDS	150	100	250	150	350	250
TDH	50	50	50	50	100	100
TAH	50	50	50	50	100	100
TCEH	50	50	50	50	100	100
TCES	300	150	450	250	600	400
TCLE	15 milliseconds					
	access time					
	500 ns		300 ns			

- Note 1: "Off Axis Viewing Angle" is here defined as: "the minimum angle in any direction from the normal to the display surface at which any part of any segment in the display is not visible".
- Note 2: This display contains a CMOS integrated circuit. Normal CMOS handling precautions should be taken to avoid damage due to high static voltages or electric fields.
- Note 3: Unused inputs must be tied to an appropriate logic voltage level (either V+ or V-).
- Note 4: **Warning** – Do not use solvents containing alcohol.

LOADING DATA

Setting the chip enables ($\overline{CE1}$, $\overline{CE2}$) to their true state will enable data loading. The desired data code (D0-D6) and digit address (A_0 , A_1) must be held stable during the write cycle for storing new data.

Data entry may be asynchronous and random. (Digit 0 is defined as right hand digit with $A_1 = A_0 = 0$.)

Clearing of the entire internal four-digit memory can be accomplished by holding the clear (\overline{CLR}) low for one complete display multiplex cycle, 15 mS minimum. Loading an illegal data code will display a blank.

LOADING CURSOR

Setting the chip enables ($\overline{CE1}$, $\overline{CE2}$) and cursor select (\overline{CU}) to their true state will enable cursor loading. A write (\overline{WR}) pulse will now store or remove a cursor into the digit location addressed by A_0 , A_1 ; as defined in data entry. A cursor will be stored if D0 = 1; and will be removed if D0 = 0. Cursor will

not be cleared by the CLR signal. The cursor (\overline{CU}) pulse width should not be less than the write (\overline{WR}) pulse or erroneous data may appear in the display.

For those users not requiring the cursor, the cursor enable signal (CUE) may be tied low to disable display of the cursor function. A flashing cursor can be realized by simply pulsing CUE. If cursor has been loaded to any or all positions in the display, then CUE will control whether the cursor(s) or the characters appear. CUE does not affect the contents of cursor memory.

DISPLAY BLANKING

Blanking the display may be accomplished by loading a blank or space into each digit of the display or by using the (\overline{BL}) display blank input.

Setting the (\overline{BL}) input low does not affect the contents of either data or cursor memory. A flashing display can be realized by pulsing (\overline{BL}).

TYPICAL LOADING DATA STATE TABLE

CONTROL							ADDRESS		DATA							DISPLAY DIGIT			
\overline{BL}	$\overline{CE1}$	$\overline{CE2}$	CUE	\overline{CU}	\overline{WR}	\overline{CLR}	A1	A0	D6	D5	D4	D3	D2	D1	D0	3	2	1	0
H	X	X	L	X	H	H			PREVIOUSLY LOADED DISPLAY							G	R	E	Y
H	H	X	L	X	X	H	X	X	X	X	X	X	X	X	X	G	R	E	Y
H	X	H	L	X	X	H	X	X	X	X	X	X	X	X	X	G	R	E	Y
H	L	L	L	H	L	H	L	L	H	L	L	L	H	L	H	G	R	E	E
H	L	L	L	H	L	H	L	H	H	L	H	L	H	L	H	G	R	U	E
H	L	L	L	H	L	H	H	L	H	L	L	H	H	L	L	G	L	U	E
H	L	L	L	H	L	H	H	H	H	L	L	L	L	H	L	B	L	U	E
L	X	X	X	X	H	H	X	X	BLANK DISPLAY							G	L	U	E
H	L	L	L	H	L	H	H	H	H	L	L	L	H	H	H				
H	X	X	L	X	H	L	X	X	CLEARS CHARACTER DISPLAYS										
H	L	L	L	H	L	H	X	X	SEE CHARACTER CODE							SEE CHARACTER SET			

X = DON'T CARE

LOADING CURSOR STATE TABLE

CONTROL							ADDRESS		DATA							DISPLAY DIGIT			
\overline{BL}	$\overline{CE1}$	$\overline{CE2}$	CUE	\overline{CU}	\overline{WR}	\overline{CLR}	A1	A0	D6	D5	D4	D3	D2	D1	D0	3	2	1	0
H	X	X	L	X	H	H			PREVIOUSLY LOADED DISPLAY							B	E	A	R
H	X	X	H	X	H	H			DISPLAY PREVIOUSLY STORED CURSORS							B	E	A	R
H	L	L	H	L	L	H	L	L	X	X	X	X	X	X	H	B	E	A	☒
H	L	L	H	L	L	H	L	H	X	X	X	X	X	X	H	B	E	☒	☒
H	L	L	H	L	L	H	H	L	X	X	X	X	X	X	H	B	☒	☒	☒
H	L	L	H	L	L	H	H	H	X	X	X	X	X	X	H	☒	☒	☒	☒
H	L	L	H	L	L	H	H	L	X	X	X	X	X	X	L	☒	E	☒	☒
H	X	X	L	X	H	H			DISABLE CURSOR DISPLAY							B	E	A	R
H	L	L	L	H	L	H	H	H	X	X	X	X	X	X	L	B	E	A	R
H	X	X	H	X	H	H			DISPLAY STORED CURSOR							B	E	☒	☒

X = DON'T CARE

CHARACTER SET

D0	L	H	L	H	L	H	L	H	L	H	L	H	L	H	L	H	L	H
D1	L	L	H	H	L	L	H	H	L	L	H	H	L	L	H	H	L	H
D2	L	L	L	L	H	H	H	H	L	L	L	L	H	H	H	H	H	H
D3	L	L	L	L	L	L	L	L	H	H	H	H	H	H	H	H	H	H
D6 D5 D4 Hex	0	1	2	3	4	5	6	7	8	9	A	B	C	D	E	F		
L H L	2	!	"	#	\$	%	&	'	<	>	*	+	,	-	.	/		
L H H	3	0	1	2	3	4	5	6	7	8	9	:	;	<	=	>	?	
H L L	4	@	A	B	C	D	E	F	G	H	I	J	K	L	M	N	O	
H L H	5	P	Q	R	S	T	U	V	W	X	Y	Z	[\]	^	_	

All other input codes display "blank"

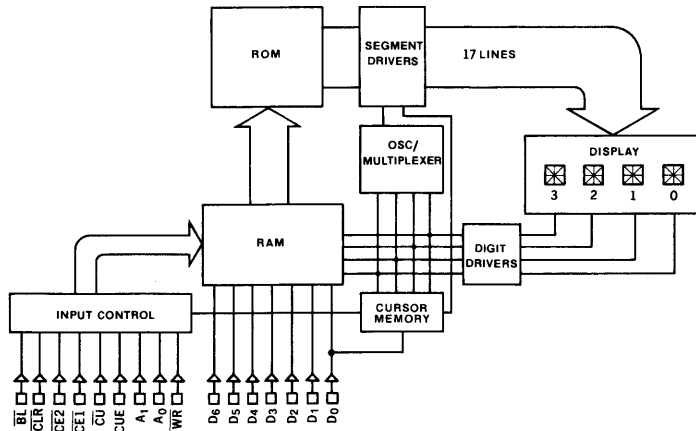

Internal Block Diagram

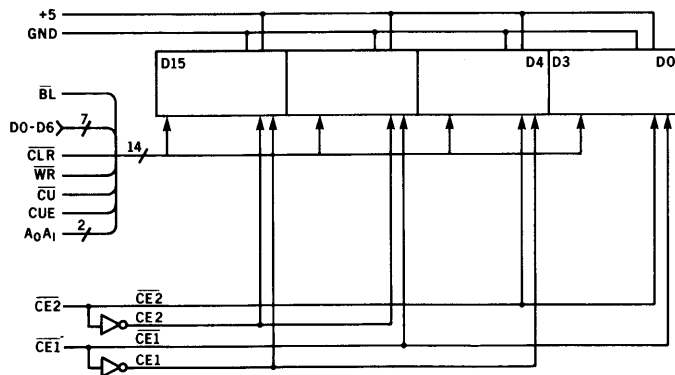

Typical Schematic for 16 Digit System

DL-3416, DL-3416 H

**.225" RED, 4-DIGIT 16-SEGMENT PLUS DECIMAL
ALPHANUMERIC Intelligent Display™
WITH MEMORY/DECODER/DRIVER**

PRELIMINARY

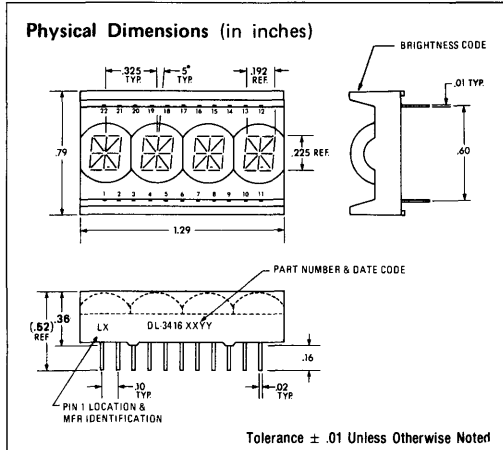
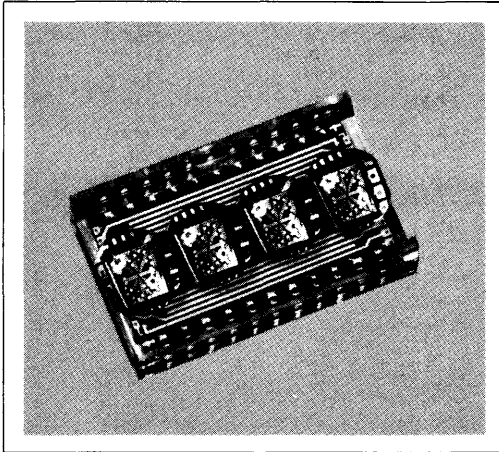

FEATURES

- 225 Mil High, Magnified Monolithic Char.
- Wide Viewing Angle $\pm 40^\circ$
- Close Vertical Row Spacing, 0.8 Inches
- Rugged Solid Plastic Encapsulated Package
- Fast Access Time
DL-3416 500 nSEC
DL-3416H 300 nSEC
- Full Size Display for Stationary Equipment
- Built-in Memory
- Built-in Character Generator
- Built-in Multiplex and LED Drive Circuitry
- Each Digit Independently Addressed
- TTL Compatible, 5 Volt Power
- Independent Cursor Function
- 17th Segment for Improved Punctuation Marks
- Memory Clear Function
- Display Blank Function
- End Stackable, 4-Character Package
- Intensity Coded for Display Uniformity

DESCRIPTION

The DL 3416 is a four digit display module having 16 segments plus decimal and a built-in CMOS integrated circuit.

The integrated circuit contains memory, ASCII ROM decoder, multiplexing circuitry, and drivers. Data entry is asynchronous and can be random. A display system can be built using any number of DL 3416's since each digit of any DL 3416 can be addressed independently and will continue to display the character last stored until replaced by another.

System interconnection is very straightforward. The least significant two address bits (A_0, A_1) are normally connected to the like named inputs of all DL 3416's in the system. With four chip enables four DL 3416's (16 characters) can easily be interconnected without a decoder.

Alternatively, one-of-n decoder IC's can be used to extend the address for large displays.

Data lines are connected to all DL 3416's directly and in parallel, as in the write line (WR). The display will then behave as a write-only memory.

The cursor function causes all segments of a digit position to illuminate. The cursor is *not* a character, however, and upon removal the previously displayed character will reappear.

Specification subject to change without notice.

TOP VIEW

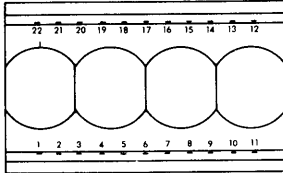

Product Identification Marking on Front Surface

Pin	Function	Pin	Function
1	CE1 Chip Enable	12	Gnd
2	CE2 Chip Enable	13	N/C
3	CE3 Chip Enable	14	BL Blanking
4	CE4 Chip Enable	15	N/C
5	CLR Clear	16	D0 Data Input
6	VCC	17	D1 Data Input
7	A0 Digit Select	18	D2 Data Input
8	A1 Digit Select	19	D3 Data Input
9	WR Write	20	D4 Data Input
10	CU Cursor Select	21	D5 Data Input
11	CUE Cursor Enables	22	D6 Data Input

OPTO-ELECTRONIC CHARACTERISTICS @ 25°C

MAXIMUM RATINGS	
Voltage, any pin respect to GND . . .	-5 to 6.0 VDC
Operating Temperature	-20° to +65°C
Storage Temperature	-20° to +70°C
Relative Humidity (non condensing) @ 65°C	85%

OPTICAL CHARACTERISTICS (TYPICAL)	
Luminous Intensity 8 segments/digit @ 5 V, 5 mcd	
Off Axis Viewing Angle (Note 1)	±40°
Digit Size	225 mils
Spectral Peak Wavelength	660 nm

DC CHARACTERISTICS DL-3416 AND DL-3416H				
Parameter	-20°C Typ	+25°C ⁴	+65°C Typ	Conditions
I _{CC} 4 digits on (10 seg/digit)	190 mA	150 mA max ¹	120 mA	V _{CC} = 5.0 V
I _{CC} Cursor ²	225 mA	175 mA max ¹	150 mA	V _{CC} = 5.0 V
I _{CC} Blank		19 mA max		V _{IN} = 0 V _{CC} = 5.0 V WR = 5.0 V
I _{IL}	225 μA	160 μA max	150 μA	V _{IN} = .8 V V _{CC} = 5.0 V
V _{IL}		.8 V max		V _{CC} = 4.5 V
V _{IH} ³		2.7 V min		V _{CC} = 4.5 V
		3.3 V min		V _{CC} = 5.5 V

1. Measured at 5 sec.
2. 60 sec max duration.
3. V_{CC} ≥ V_{IH} ≥ 0.6 V_{CC}.
4. V_{CC} = +5.0 VDC ±10%

TIMING CHARACTERISTICS

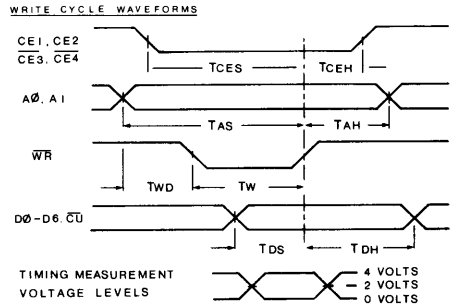

AC CHARACTERISTICS Timing Parameters @ 4.5 V (nanoseconds)						
Parameter	-20°C Typ		+25°C Min		+65°C Typ	
	DL-3416	DL-3416H	DL-3416	DL-3416H	DL-3416	DL-3416H
TAS	300	200	450	250	600	400
TWD	50	50	150	50	175	75
TW	250	150	300	200	425	325
TDS	150	100	250	150	350	250
TDH	50	50	50	50	100	100
TAH	50	50	50	50	100	100
TCEH	50	50	50	50	100	100
TCEH	300	150	450	250	600	400
TCLR	15 milliseconds					
	access time					
	500 ns		300 ns			

- Note 1: "Off Axis Viewing Angle" is here defined as: "the minimum angle in any direction from the normal to the display surface at which any part of any segment in the display is not visible".
- Note 2: This display contains a CMOS integrated circuit. Normal CMOS handling precautions should be taken to avoid damage due to high static voltages or electric fields.
- Note 3: Unused inputs must be tied to an appropriate logic voltage level (either V+ or V-).
- Note 4: Warning – Do not use solvents containing alcohol.

LOADING DATA

Setting the chip enables (CE1, CE2, $\overline{CE3}$, $\overline{CE4}$) to their true state will enable data loading. The desired data code (D0-D6) and digit address (A₀, A₁) should be held stable during the write cycle for storing new data.

Data entry may be asynchronous and random. (Digit 0 is defined as right hand digit with A₁ = A₀ = 0.)

Clearing of the entire internal four-digit memory can be accomplished by holding the clear (CLR) low for one complete display multiplex cycle, 15 mS minimum.

LOADING CURSOR

Setting the chip enables (CE1, CE2, $\overline{CE3}$, $\overline{CE4}$) and cursor select (\overline{CU}) to their true state will enable cursor loading. A write (\overline{WR}) pulse will now store or remove a cursor into the digit location addressed by A₀, A₁; as defined in data entry. A cursor will be stored if D0 = 1; and will be removed if D0 = 0. Cursor will not be cleared by the \overline{CLR} signal. The

cursor (\overline{CU}) pulse width should not be less than the write pulse (\overline{WR}) width or erroneous data may appear in the display.

For those users not requiring the cursor, the cursor enable signal (CUE) may be tied low to disable display of the cursor function. A flashing cursor can be realized by simply pulsing CUE. If cursor has been loaded to any or all positions in the display, then CUE will control whether the cursor(s) or the characters appear. CUE does not affect the contents of cursor memory.

DISPLAY BLANKING

Blanking the display may be accomplished by loading a blank or space into each digit of the display or by using the (BL) display blank input.

Setting the (BL) input low does not affect the contents of either data or cursor memory. A flashing display can be realized by pulsing (BL).

TYPICAL LOADING DATA STATE TABLE

\overline{BL}	CE1	CE2	$\overline{CE3}$	$\overline{CE4}$	CUE	\overline{CU}	\overline{WR}	\overline{CLR}	A1	A0	D6	D5	D4	D3	D2	D1	D0	DIGIT				
																		3	2	1	0	
H	X	X	X	X	L	X	H	H			PREVIOUSLY LOADED DISPLAY							G	R	E	Y	
H	L	X	X	X	L	X	X	H	X	X	X	X	X	X	X	X	X	X	G	R	E	Y
H	X	L	X	X	L	X	X	H	X	X	X	X	X	X	X	X	X	X	G	R	E	Y
H	X	X	H	X	L	X	X	H	X	X	X	X	X	X	X	X	X	X	G	R	E	Y
H	X	X	X	H	L	X	X	H	X	X	X	X	X	X	X	X	X	X	G	R	E	Y
H	X	X	X	L	X	H	H	H	X	X	X	X	X	X	X	X	X	X	G	R	E	Y
H	H	H	L	L	L	H	L	H	L	L	H	L	L	L	H	L	H	G	R	E	E	
H	H	H	L	L	L	H	L	H	L	H	H	L	H	L	H	L	H	G	R	U	E	
H	H	H	L	L	L	H	L	H	H	L	H	L	L	H	H	L	L	G	L	U	E	
H	H	H	L	L	L	H	L	H	H	H	H	L	L	L	L	H	L	B	L	U	E	
L	X	X	X	X	X	X	H	H	X	X	BLANK DISPLAY							G	L	U	E	
H	H	L	L	L	L	H	L	H	H	H	H	L	L	L	H	H	H	G	L	U	E	
H	X	X	X	X	L	X	X	L	X	X	CLEARS CHARACTER DISPLAY											
H	H	H	L	L	L	H	L	H	X	X	SEE CHARACTER CODE											

X = DON'T CARE

LOADING CURSOR STATE TABLE

\overline{BL}	CE1	CE2	$\overline{CE3}$	$\overline{CE4}$	CUE	\overline{CU}	\overline{WR}	\overline{CLR}	A1	A0	D6	D5	D4	D3	D2	D1	D0	DIGIT			
																		3	2	1	0
H	X	X	X	X	L	X	H	H			PREVIOUSLY LOADED DISPLAY							B	E	A	R
H	X	X	X	X	H	X	H	H			DISPLAY PREVIOUSLY STORED CURSORS							B	E	A	R
H	H	H	L	L	H	L	L	H	L	L	X	X	X	X	X	X	H	B	E	A	R
H	H	H	L	L	H	L	L	H	H	L	X	X	X	X	X	X	H	B	E	A	R
H	H	H	L	L	H	L	L	H	H	H	X	X	X	X	X	X	H	B	E	A	R
H	H	H	L	L	L	L	L	H	H	L	X	X	X	X	X	X	L	B	E	A	R
H	X	X	X	X	L	X	H	H			DISABLE CURSOR DISPLAY							B	E	A	R
H	H	H	L	L	L	L	L	H	H	H	X	X	X	X	X	X	L	B	E	A	R
H	X	X	X	X	H	X	H	H			DISPLAY STORED CURSORS							B	E	A	R

X = DON'T CARE

CHARACTER SET

D0	L	H	L	H	L	H	L	H	L	H	L	H	L	H	L	H	
D1	L	L	H	H	L	L	H	H	L	L	H	H	L	L	H	H	
D2	L	L	L	L	H	H	H	H	L	L	L	H	H	H	H	H	
D3	L	L	L	L	L	L	L	L	H	H	H	H	H	H	H	H	
D6 D5 D4	HEX	0	1	2	3	4	5	6	7	8	9	A	B	C	D	E	F
L H L	2		!	"	#	\$	%	&	'	<	>	*	+	,	-	.	/
L H H	3	0	1	2	3	4	5	6	7	8	9	:	;	<	=	>	?
H L L	4	a	b	c	d	e	f	g	h	i	j	k	l	m	n	o	
H L H	5	p	q	r	s	t	u	v	w	x	y	z	[\]	^	_

ALL OTHER CODES DISPLAY BLANK

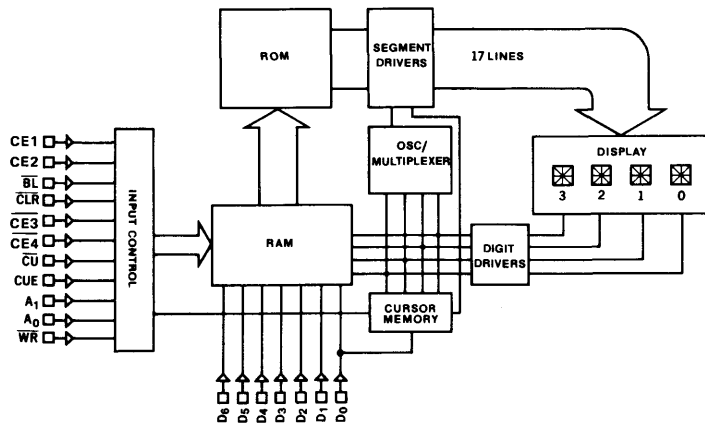

Internal Block Diagram

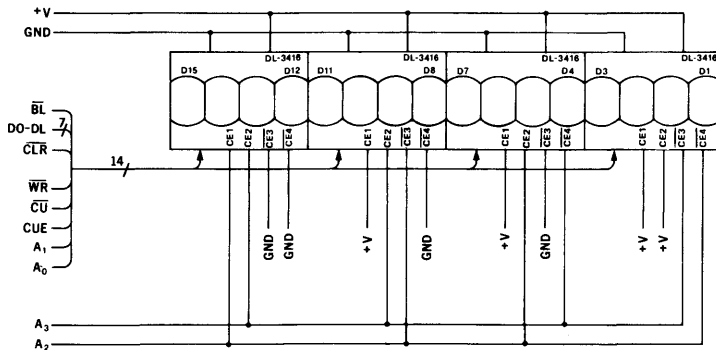

Typical Schematic for 16 Digits

DL-3422
.170"/.100" (Nom.) UPPER AND LOWER CASE
4-DIGIT 22-SEGMENT
ALPHANUMERIC Intelligent Display™
WITH MEMORY/DECODER/DRIVER
PRELIMINARY

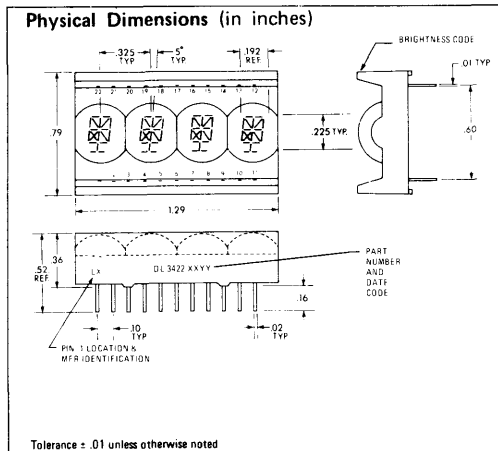
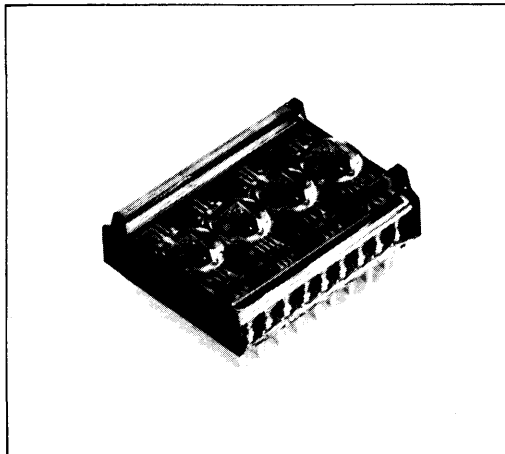

FEATURES

- **170Mil/100Mil (Nom.) Upper & Lower Case Letters**
- **Wide Viewing Angle ± 50°**
- **Close Vertical Row Spacing, .800 Inches**
- **Rugged Solid Plastic Encapsulated Package**
- **Fast Access Time, 500 nSEC**
- **Full Size Display for Stationary Equipment**
- **Built-in Memory**
- **Built-in Character Generator**
- **Built-in Multiplex and LED Drive Circuitry**
- **Direct Access to Each Digit Independently & Asynchronously**
- **TTL Compatible, 5 Volt Power**
- **Independent Cursor Function**
- **22 Segment for 96 Character ASCII Format Upper & Lower Case Letters**
- **Memory Clear Function**
- **Display Blank Function**

DESCRIPTION

The DL 3422 is a four digit display module having 22 segments and a built-in CMOS integrated circuit.

The integrated circuit contains memory, ASCII ROM decoder, multiplexing circuitry, and drivers. Data entry is asynchronous and can be random. A display system can be built using any number of DL 3422's since each digit of any DL 3422 can be addressed independently and will continue to display the character last stored until replaced by another.

System interconnection is very straightforward. The least significant two address bits (A_0 , A_1) are normally connected to the like named inputs of all DL 3422's in the system. With two chip enables ($\overline{CE1}$, and $\overline{CE2}$) four DL 3422's (16 characters) can easily be interconnected without a decoder.

Alternatively, one-of-n decoder 1C's can be used to extend the address for large displays.

Data lines are connected to all DL 3422's directly and in parallel, as is the write line (\overline{WR}). The display will then behave as a write-only memory.

The cursor function causes all segments of a digit position to illuminate. The cursor is *not* a character, however, and upon removal the previously displayed character will reappear.

Specification subject to change without notice.

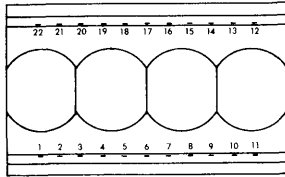

Pin	Function	Pin	Function
1	CE1 Chip Enable	12	Gnd
2	N/C	13	N/C
3	CE2 Chip Enable	14	BL Blanking
4	N/C	15	N/C
5	CLR Clear	16	D0 Data Input
6	VCC	17	D1 Data Input
7	A0 Digit Select	18	D2 Data Input
8	A1 Digit Select	19	D3 Data Input
9	WR Write	20	D4 Data Input
10	CU Cursor Select	21	D5 Data Input
11	CUE Cursor Enable	22	D6 Data Input

OPTO-ELECTRONIC CHARACTERISTICS @ 25°C

MAXIMUM RATINGS

Voltage, any pin respect to GND . . . -5 to 6.0 VDC
 Operating Temperature -20° to +65°C
 Storage Temperature -20° to +70°C
 Relative Humidity
 (non condensing) @ 65°C 85%

OPTICAL CHARACTERISTICS

Luminous Intensity 8 Segments @ 5 V 5 mcd
 Off Axis Viewing Angle (Note 1) ±50°
 Digit Size 160 mils
 Spectral Peak Wavelength 660 nm

DC CHARACTERISTICS

Parameter	-20°C Typ	+25°C ⁴	+65°C Typ	Conditions
I _{CC} 4 digits on (10 seg/digit)	135 mA	125 mA max ¹	100 mA	V _{CC} = 5.0 V
I _{CC} 4 digits or Cursor ²	160 mA	140 mA max ¹	120 mA	V _{CC} = 5.0 V
I _{CC} Blank		3.7 mA max		V _{IN} = 0 V _{CC} = 5.0 V WR = 5.0 V
I _{IL}	200 μA	160 μA max	100 μA	V _{IN} = .8 V V _{CC} = 5.0 V
V _{IL}		.8 V max		V _{CC} = 4.5 V
V _{IH} ³		2.7 V min		V _{CC} = 4.5 V
		3.3 V min		V _{CC} = 5.5 V

1. Measured at 5 sec.
2. 60 sec max duration.
3. V_{CC} ≥ V_{IH} ≥ 0.6 V_{CC}.
4. V_{CC} = +5.0 VDC ±10%

AC CHARACTERISTICS

Timing Parameter @ 4.5 V (nanoseconds)

	-20°C Typ	+25°C Min	+65°C Typ
T _{AS}	300	450	600
T _{WD}	50	150	175
T _W	250	300	425
T _{DS}	150	250	350
T _{DH}	50	50	100
T _{AH}	50	50	100
T _{C EH}	50	50	100
T _{C ES}	300	450	600
T _{CLR}		15 milliseconds	

TIMING CHARACTERISTICS

Write Cycle Waveforms

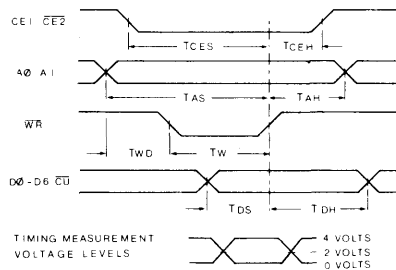

Note 1: "Off Axis Viewing Angle" is here defined as: "the minimum angle in any direction from the normal to the display surface at which any part of the segment in the display is not visible".

Note 2: This display contains a CMOS integrated circuit. Normal CMOS handling precautions should be taken to avoid damage due to high static voltages or electric fields.

Note 3: Unused inputs must be tied to an appropriate logic voltage level (either V+ or V-).

Note 4: Warning — Do not use solvents containing alcohol.

LOADING DATA

Setting the chip enables ($\overline{CE1}$, $\overline{CE2}$) to their true state will enable data loading. The desired data code (D0-D6) and digit address (A_0 , A_1) should be held stable during the write cycle for storing new data.

Data entry may be asynchronous and random. (Digit 0 is defined as right hand digit with $A_1 = A_0 = 0$.)

Clearing of the entire internal four-digit memory can be accomplished by holding the clear (\overline{CLR}) low for one complete display multiplex cycle, 15 mS minimum.

LOADING CURSOR

Setting the chip enables ($\overline{CE1}$, $\overline{CE2}$) and cursor select (\overline{CU}) to their true state will enable cursor loading. A write (\overline{WR}) pulse will now store or remove a cursor into the digit location addressed by A_0 , A_1 ; as defined in data entry. A cursor will be stored if $DO = 1$; and will be removed if $DO = 0$. Cursor will

not be cleared by the \overline{CLR} signal.

For those users not requiring the cursor, the cursor enable signal (CUE) may be tied low to disable display of the cursor function. A flashing cursor can be realized by simply pulsing CUE. If cursor has been loaded to any or all positions in the display, then CUE will control whether the cursor(s) or the characters appear. CUE does not affect the contents of cursor memory.

DISPLAY BLANKING

Blanking the display may be accomplished by loading a blank or space into each digit of the display or by using the (\overline{BL}) display blank input.

Setting the (\overline{BL}) input low does not affect the contents of either data or cursor memory. A flashing display can be realized by pulsing (\overline{BL}).

TYPICAL LOADING DATA STATE TABLE

\overline{BL}	$\overline{CE1}$	$\overline{CE2}$	CUE	\overline{CU}	\overline{WR}	\overline{CLR}	A_1	A_0	D6	D5	D4	D3	D2	D1	D0	DIGIT			
																3	2	1	0
H	X	X	L	X	H	H	PREVIOUSLY LOADED DISPLAY									G	R	E	Y
H	L	X	L	X	X	H	X	X	X	X	X	X	X	X	X	G	R	E	Y
H	X	X	L	X	X	H	X	X	X	X	X	X	X	X	X	G	R	E	Y
H	X	H	L	X	X	H	X	X	X	X	X	X	X	X	X	G	R	E	Y
H	X	X	L	X	X	H	X	X	X	X	X	X	X	X	X	G	R	E	Y
H	X	X	L	X	H	H	X	X	X	X	X	X	X	X	X	G	R	E	Y
H	H	L	L	H	L	H	L	L	H	L	L	H	L	H	G	R	E	E	
H	H	L	L	H	L	H	L	H	H	L	H	L	H	H	G	R	U	E	
H	H	L	L	H	L	H	H	L	H	L	L	H	L	L	G	L	U	E	
H	H	L	L	H	L	H	H	H	H	L	L	L	H	L	B	L	U	E	
O	X	X	X	X	H	H	BLANK DISPLAY									G	L	U	E
H	H	L	L	H	L	H	H	H	H	L	L	L	H	H	G	L	U	E	
H	X	X	L	X	X	L	CLEARS CHARACTER DISPLAY									SEE CHARACTER SET			
H	H	L	L	H	L	H	X	X	SEE CHARACTER CODE							SEE CHARACTER SET			

X = DON'T CARE

LOADING CURSOR STATE TABLE

\overline{BL}	$\overline{CE1}$	$\overline{CE2}$	CUE	\overline{CU}	\overline{WR}	\overline{CLR}	A_1	A_0	D6	D5	D4	D3	D2	D1	D0	DIGIT			
																3	2	1	0
H	X	X	L	X	H	H	PREVIOUSLY LOADED DISPLAY									B	E	A	R
H	X	X	H	X	H	H	DISPLAY PREVIOUSLY STORED CURSORS									B	E	A	R
H	H	L	H	L	L	H	L	L	X	X	X	X	X	X	B	E	A	☒	
H	H	L	H	L	L	H	L	H	X	X	X	X	X	H	B	E	☒	☒	
H	H	L	H	L	L	H	H	L	X	X	X	X	X	H	B	☒	☒	☒	
H	H	L	H	L	L	H	H	H	X	X	X	X	X	H	☒	☒	☒	☒	
H	H	L	H	L	L	H	H	L	X	X	X	X	X	L	☒	☒	☒	☒	
H	X	X	L	X	H	H	DISABLE CURSOR DISPLAY									B	E	A	R
H	H	L	L	H	L	H	H	H	X	X	X	X	X	L	B	E	A	R	
H	X	X	H	X	H	H	DISPLAY STORED CURSORS									B	E	☒	☒

X = DON'T CARE

CHARACTER SET

		D0		D1		D2		D3		D4		D5		D6		D7			
		L	H	L	H	L	H	L	H	L	H	L	H	L	H	L	H		
D0		L	L	H	H	L	L	H	H	L	L	H	H	L	L	H	H		
D1		L	L	L	L	L	L	L	L	L	L	L	L	L	L	L	L		
D2		L	L	L	L	L	L	L	L	L	L	L	L	L	L	L	L		
D3		L	L	L	L	L	L	L	L	L	L	L	L	L	L	L	L		
D6	D5	D4	Hex	0	1	2	3	4	5	6	7	8	9	A	B	C	D	E	F
L	H	L	2		.	"	‡	§	%	&	'	[]	*	+	,	-	.	/
L	H	H	3	0	1	2	3	4	5	6	7	8	9	:	;	<	=	>	?
H	L	L	4	a	A	B	C	D	E	F	G	H	I	J	K	L	M	N	O
H	L	H	5	P	Q	R	S	T	U	V	W	X	Y	Z	[\]	^	_
H	H	L	6	\	a	b	c	d	e	f	g	h	i	j	k	l	m	n	o
H	H	H	7	p	q	r	s	t	u	v	w	x	y	z	{		}	~	

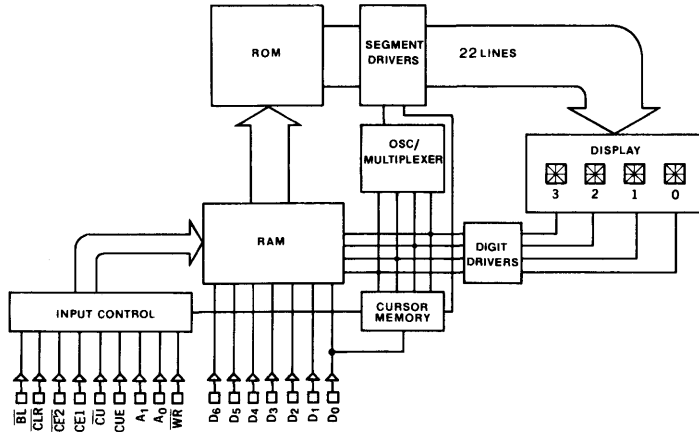

Internal Block Diagram

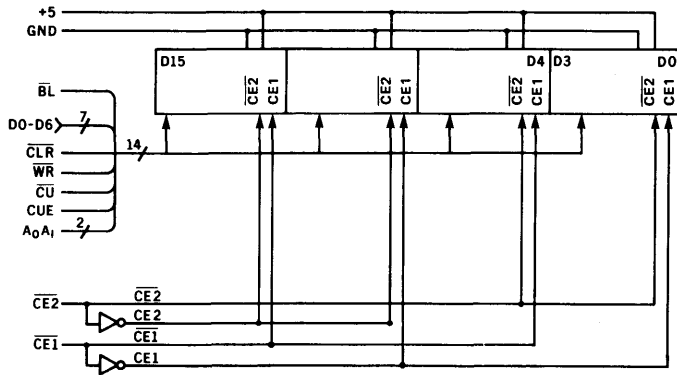

Typical Schematic for 16 Digit System

IDA-2416 Series

DL-2416 Intelligent Display™ ASSEMBLY

PRELIMINARY

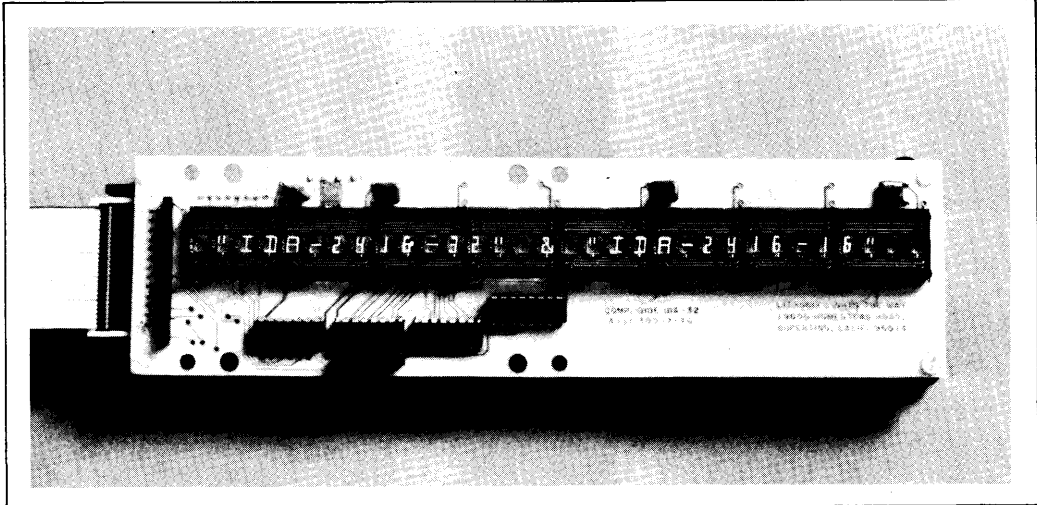

FEATURES

- Complete Alphanumeric Display Assembly Utilizing the DL-2416
 - Built-in Multiplex and LED Drive Circuitry
 - Built-in Memory
 - Built-in Character Generator
- Displays 64 Character ASCII Set
- Direct Access to Each Digit Independently
- Display Blank Function
- Memory Clear Function
- Cursor Function
- Choice of 16 or 32 Character Display Length (Other lengths optional)
- Single 5.0 Volt Power Supply
- TTL Compatible
- Easily Interfaced to a Microprocessor
- Tri-State or Open-Collector Input Circuitry
- Schmitt Trigger Inputs on Control Lines

The IDA-2416 Series Assembly is an extension of the very easy-to-use DL-2416 Intelligent Display™. This product provides the designer with circuitry for display maintenance. It also minimizes interaction and interface normally required between the user's system and a multiplexed alphanumeric display.

The assembly consists of DL-2416's in a single row together with decoder and interface buffers on a single printed circuit board. Each DL-2416 provides its own memory, ASCII ROM character decoder, multiplexing circuitry, and drivers for its four 17-segment LED's.

Intelligent Display Assemblies can be used for applications such as data terminals, controllers, instruments, and other products which require an easy to use alphanumeric display.

Part Number	Description
IDA-2416-16	Single Line 16 Character Alphanumeric Display Utilizing the DL-2416
IDA-2416-32	Single Line 32 Character Alphanumeric Display Utilizing the DL-2416
IDA-2416-XX-YY	Single Line Alphanumeric Display Utilizing the DL-2416 Display XX — indicates number of characters (groups of four) from 16 to 40 YY — options or specials versions (consult factory for more information)

System Overview

The Intelligent Display Assembly offers the designer a choice of either 16 or 32 alphanumeric characters (the IDA-2416-16 and IDA-2416-32, respectively), and operates from just a +5-V supply. Based on the previously introduced Litronix DL-2416 four-character intelligent display, the IDA-2416 adds all the support logic required for direct connection to most microprocessor buses. The system interface takes place through a 26-pin connector, which has available on it the data and address lines as well as the control signals needed. Two additional connectors are included on the IDA-2416 — one of them is used for the power and ground connections, and the other is used to implement display enable selection.

System Power Requirements

Operating from a single +5-V power supply, the IDA-2416-16 requires a typical operating current of 450 mA with eight of the segments lit on each character. For the 32 character display, the current increases to 850 mA, typical. For the worst-case condition with all segments lit, the 16 character display draws 650 mA and the 32 character display requires 1250 mA. With the display blanked, the board circuitry draws about 70 mA.

Display Interface

The display interface available on the 26-pin connector consists of seven data lines (D0 to D6), five address lines (A0 to A4), four display-enable lines ($\overline{DE1}$ to $\overline{DE4}$), several unused pins, and various control signals. All address, data, and control lines have either pull-up or pull-down 1K ohm resistors.

\overline{BL} (Blanking, active low): When this line is pulled low, it causes the entire IDA display to go blank without affecting the contents of the display memory on the DL-2416s. \overline{BL} is active regardless of address or display enable lines. A flashing display can be realized by pulsing this line.

\overline{WR} (Write, active low): To store a character in the display memory, this line must be pulsed low for a minimum of 200 ns. See timing diagram for timing & relationships to other signals. The \overline{WR} input drives a schmitt-trigger.

CUE (Cursor Enable, active high): When high, this line permits the cursor to be displayed, and when brought low, it disables the cursor function without affecting the stored value. CUE is active regardless of address or display enable lines. A flashing cursor can be created by pulsing the CUE line low.

\overline{CU} (Cursor Select, active low): The cursor function (character with all segments lit) is loaded by selecting the digit address and holding \overline{CU} true. A "1" on D0

writes the cursor. A "0" on D0 removes the cursor. The change occurs during the next write pulse per the timing diagram.

\overline{CLR} (Clear, active low): When held low for one display multiplex cycle (see DL-2416 data sheet for more information) of 15 ms, this line will cause all stored characters in the display, except for the cursor, to be cleared. \overline{CLR} is active regardless of address or display enable lines. The \overline{CLR} input drives a schmitt-trigger.

$\overline{DE1}$ to $\overline{DE4}$ (Display Enable, active low): There are four jumper selectable lines, any one of which can be selected to provide one of four board addresses that can be used when multiple IDAs are built into a system. When low, this line enables the selected display to permit data loading. The display enable input drives a schmitt-trigger.

Address lines A0 to A4 are set up so that the right-most character is the lowest address. The left-most character is the highest address. Data lines are set up so that D0 is the least significant bit and D6 is the most significant bit.

Using the Display Interface

Through the use of memory-mapped I/O techniques, the IDA can be treated almost like a memory location — supply the data, address and proper control signals and the characters appear, with each character location independently addressable. The basic signal flow sequence to load a character would start with the address lines going to the desired address while the \overline{CLR} and \overline{BL} lines are high to permit the data to be loaded in and displayed. After the address has stabilized, the data can change to the desired values (including the cursor). After the data have stabilized, the \overline{WR} pulse is started, and must remain low for at least 200 ns. Signals must be held stable for 75 ns, minimum, after the rising edge of the \overline{WR} pulse to ensure correct loading, while the addresses must be stable for 650 ns preceding the same rising edge of the \overline{WR} pulse. See the timing diagram for a pictorial explanation.

Enable Selection

For board enable (the $\overline{DE1}$ through $\overline{DE4}$ lines) the user can choose any one of the four enable signals he has provided on the cable. This signal will be used to provide a master enable to each IDA. All that need be done is to insert the shorting plug in the appropriate position on the pins provided. This allows the user to make the system display the same information on two or more different IDAs or display different information on each of up to four groups of IDA's.

IDA-2416 Series

Maximum Ratings

V_{CC}	6.0 V
Voltage applied to any input	-0.5 to $V_{CC} + 0.5$ VDC
Operating Temperature	-20 to +65°C
Storage Temperature	-20 to +70°C
Relative Humidity (non condensing) @ 65°C	85%

Optoelectronic Characteristics @ 25°C

Parameter	Symbol	Min	Typ	Max	Units	Test Conditions
Supply Current/Digit	I_{CC}		25		mA	$V_{CC} = 5.0$ V (8 Segments/Digit)
Total (IDA-2416-16)	I_{CC}			650	mA	$V_{CC} = 5.0$ V (All Segments/Digit)
Total (IDA-2416-32)	I_{CC}			1250	mA	$V_{CC} = 5.0$ V (All Segments/Digit)
Supply Voltage	V_{CC}	4.75	5.00	5.25	V	
Input Voltage – High (All inputs)	V_{IH}	2			V	$V_{CC} = 5.0$ V \pm .25 V
Input Voltage – Low (All inputs)	V_{IL}			0.8	V	$V_{CC} = 5$
Input Current – High (All inputs)	I_{IH}			40	μ A	$V_{CC} = 5.5$ V, $V_I = 2.4$ V
Input Current – Low (All inputs)	I_{IL}			2.2	mA	$V_{CC} = 5.5$ V, $V_I = 0.4$ V
Luminous Intensity Average Per Digit	I_V		0.5		mcd	$V_{CC} = 5.0$ V (8 Segments/Digit)
Peak Wavelength	λ_{peak}		660		nm	
Viewing Angle			± 45		Deg	Vertical & Horizontal From Normal To Display Plane

Switching Characteristics @ 5 V

Parameter @ 25°C	Symbol	Min	Units
Write Pulse	T_W	200	nS
Address/DE Setup Time	T_{AS}	650	nS
Data Setup Time	T_{DS}	650	nS
Write Setup	T_{WD}	200	nS
Data Hold Time	T_{DH}	75	nS
Address/DE Hold Time	T_{AH}	75	nS
Clear Time	T_{CLR}	15	mS

TIMING CHARACTERISTICS

WRITE CYCLE WAVEFORMS

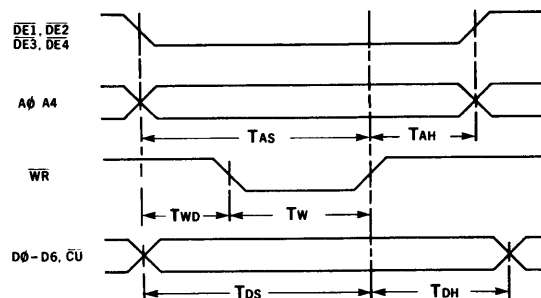

TIMING MEASUREMENT VOLTAGE LEVELS

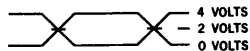

Physical Dimensions

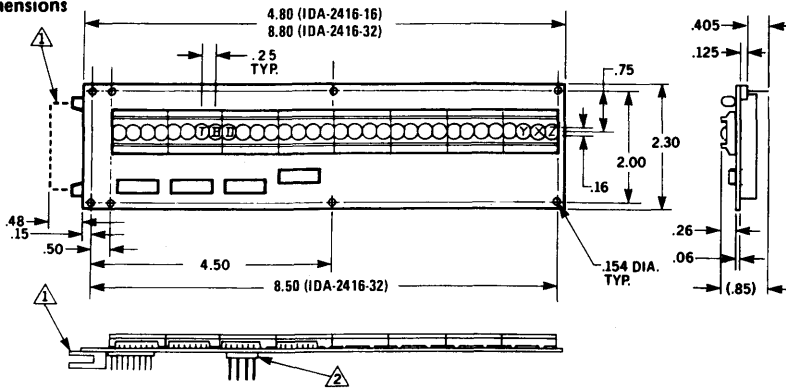

RECOMMENDED MATING CONNECTOR

Connector	Function	Type	Suggested Mfg.
J2	Control/Data	26-Pin Ribbon	BERG P/N 65496-013
J3	Power	Molex	AMP P/N 87066-4

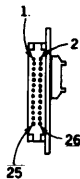

PIN	FUNCTION	PIN	FUNCTION
J2-1	A2 ADDRESS LINE	J2-14	NO CONNECTION
J2-2	DE4 DISPLAY ENABLE	J2-15	D6 DATA LINE
J2-3	A3 ADDRESS LINE	J2-16	NO CONNECTION
J2-4	DE3 DISPLAY ENABLE	J2-17	D4 DATA LINE
J2-5	A4 ADDRESS LINE	J2-18	CUE CURSOR ENABLE
J2-6	DE1 DISPLAY ENABLE	J2-19	D5 DATA LINE
J2-7	NO CONNECTION	J2-20	CUR CURSOR SELECT
J2-8	DE2 DISPLAY ENABLE	J2-21	A0 ADDRESS LINE
J2-9	D0 DATA LINE	J2-22	CLR CLEAR
J2-10	NO CONNECTION	J2-23	A1 ADDRESS LINE
J2-11	D1 DATA LINE	J2-24	WR WRITE
J2-12	NO CONNECTION	J2-25	D3 DATA LINE
J2-13	D2 DATA LINE	J2-26	BL BLANKING
J3-1	GND	J3-3	VCC
J3-2	VCC	J3-4	GND

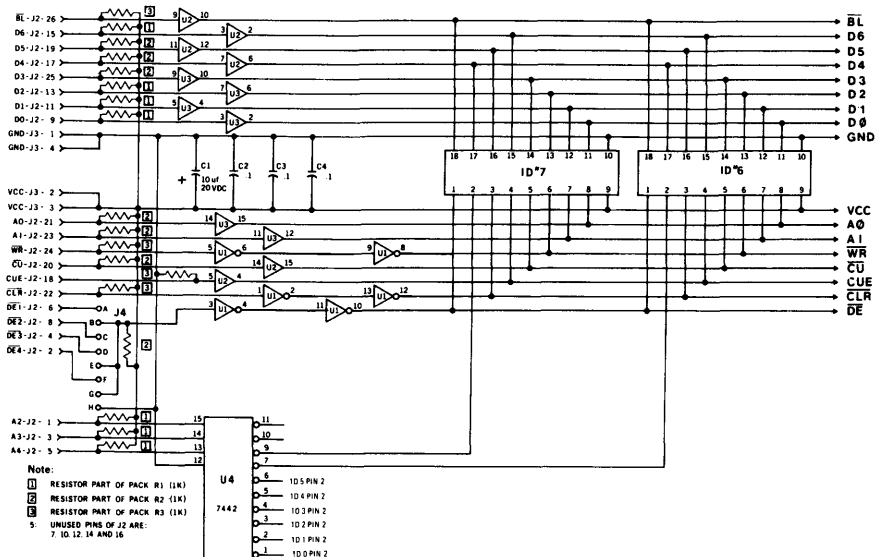

LED LAMPS

**RL-2000
RL-4403
RL-4850**

RED T1^{3/4} LED LAMP

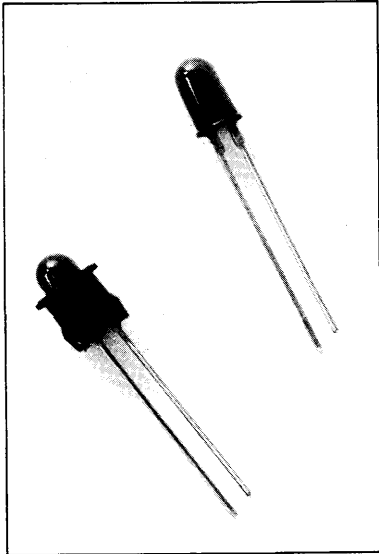

Package Dimensions in Inches

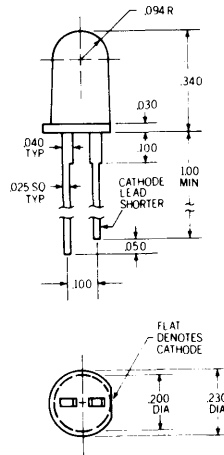

BOTTOM VIEW

FEATURES

- Choice of Brightness Ranges
- Front Panel Mounting
- Large Full Flood Radiating Area
- IC Compatible
- Snap-in Mounting Clip

DESCRIPTION

The RL-2000, RL-4403 and RL-4850 are high brightness gallium arsenide phosphide solid-state lamps with a red diffused plastic lens which provides a large full flooded front radiating area and wide angle viewing. These devices are easily soldered directly into a PC board or mounted in a panel with a snap-in mounting clip.

Maximum Ratings

Power Dissipation @ 25°C	100 mW
Derate Linearly from 25°C	- 2.67 mW/°C
Continuous Forward Current	50 mA
Storage and Operating Temperature	-55°C to +100°C
Lead Soldering Temperature (1/16 in. from case)	5 sec @ 260°C
Peak Inverse Voltage	3.0 V

Opto-Electronic Characteristics (@ 25°C)

Parameter	Min	Typ	Max	Unit	Test Condition
Luminous Intensity					
RL-2000	1.6	2.5		mcd	I _F = 20 mA
RL-4403	0.8	1.2		mcd	I _F = 20 mA
RL-4850		0.8		mcd	I _F = 20 mA
Emission Peak Wave Length		650		nm	
Spectral Line Half-Width		40		nm	
Forward Voltage	1.6	2.0		V	I _F = 20 mA
Reverse Leakage	0.1	100		µA	V _R = 3.0 V
Temperature Coefficient of Forward Voltage		-1.8		mV/°C	I _F = 5 to 50 mA

TYPICAL OPTO-ELECTRONIC CHARACTERISTIC CURVES

RELATIVE LUMINOUS INTENSITY VS ANGLE

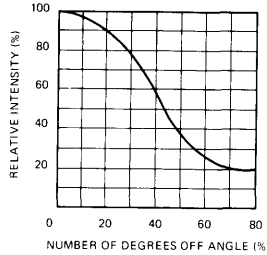

LUMINOUS INTENSITY VS AMBIENT TEMPERATURE

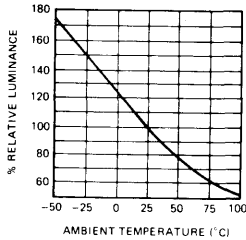

SPECTRAL DISTRIBUTION

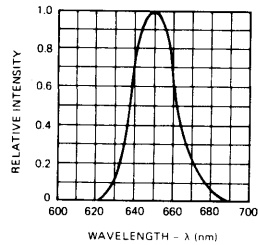

FORWARD CURRENT VS FORWARD VOLTAGE

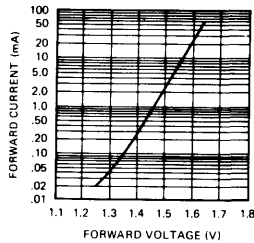

LUMINOUS INTENSITY VS FORWARD CURRENT

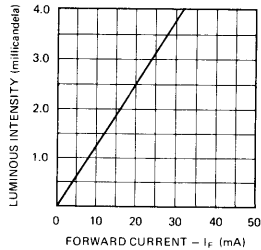

Mounting Information

The clip mounts in a .250" dia. hole and fits up to .125" panel thickness. A plastic collar is provided which fits over the back of the clip to lock the LED securely against the panel.

BLACK CLIP AND COLLAR: 004-9002

CLEAR CLIP AND COLLAR: 004-9003

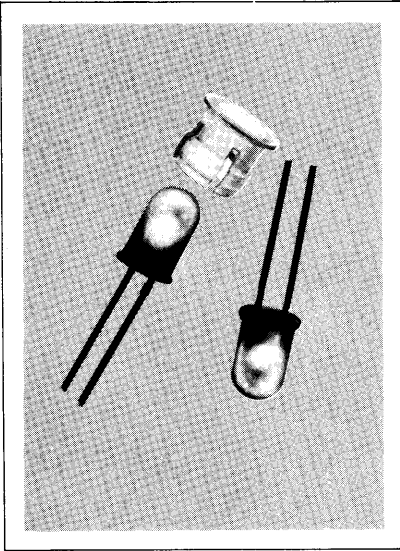

FEATURES

- 1 Inch Leads – No Standoffs
- Large Full Flood Radiating Area
- Four Brightness Groups
- IC Compatible
- Snap-in Mounting Clip available for easy panel mounting. Black P/N 004-9002
Clear P/N 004-9003

DESCRIPTION

The RL-5053 series is a Gallium Arsenide Phosphide solid state lamp with a red diffused plastic lens which provides a large full flooded front radiating area and wide angle viewing. These devices are easily soldered directly into a PC board or mounted in a panel with a snap-in mounting clip.

Package Dimensions in Inches (mm)

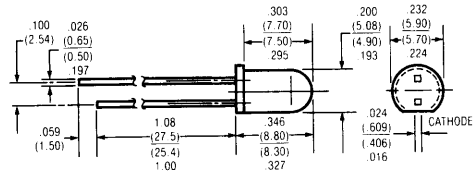

Maximum Ratings

Power Dissipation @ 25°C	200mW
Derate Linearly from 25°C	-2.67 mW/°C
Continuous Forward Current	100 mA
Recurrent Peak Forward Current (1 μsec pulse @ .1% duty cycle)	5 A
Storage & Operating Temperature	-55 to +100°C
Lead Soldering Temperature (1/16 in. from case)	5 sec @ 260°C
Peak Inverse Voltage	5.0 V

Opto-Electronic Characteristics (at 25°C)

Parameter	Min	Typ	Max	Unit	Test Condition
Luminous Intensity				mcd	I _F = 20 mA
RL-5053-A	0.3				
RL-5053-1	1.0		2.0		
RL-5053-2	1.6		3.2		
RL-5053-3	2.5				
Emission Peak Wavelength	650	665		nm	
Spectral Line Half-Width	40			nm	
Half Angle	35			degree	
Forward Voltage	1.6	2.0		V	I _F = 20 mA
Reverse Leakage	.01	10		μA	V _R = 5.0 V

Specifications subject to change without notice.

TYPICAL OPTO-ELECTRONIC CHARACTERISTIC CURVES

RELATIVE LUMINOUS INTENSITY VS ANGLE

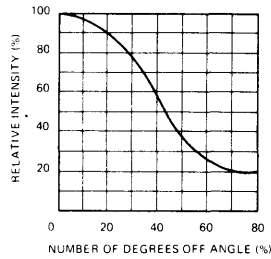

LUMINOUS INTENSITY VS AMBIENT TEMPERATURE

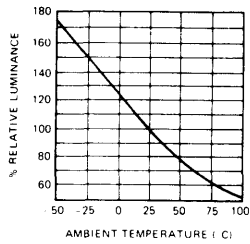

SPECTRAL DISTRIBUTION

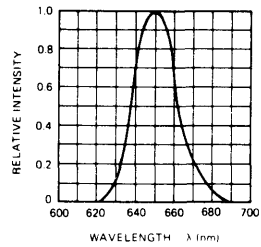

FORWARD CURRENT VS FORWARD VOLTAGE

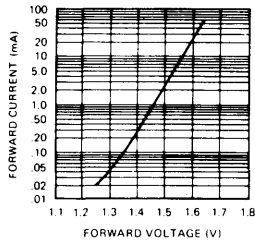

LUMINOUS INTENSITY VS FORWARD CURRENT

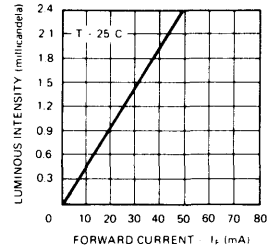

Mounting Information

The clip mounts in a .250" dia. hole and fits up to .125" panel thickness. A plastic collar is provided which fits over the back of the clip to lock the LED securely against the panel.

BLACK CLIP AND COLLAR: 004-9002
 CLEAR CLIP AND COLLAR: 004-9003

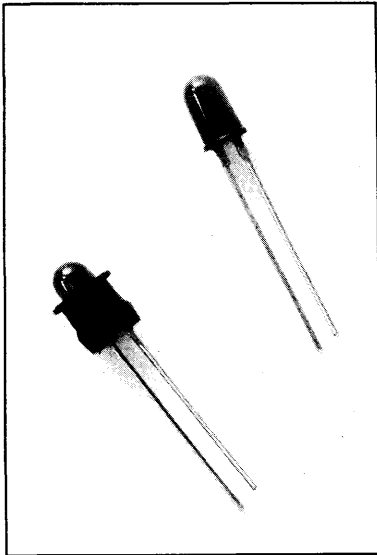

FEATURES

- RL-5054-1 — 1 mcd Min at $I_F = 10 \text{ mA}$
- RL-5054-2 — 2 mcd Min at $I_F = 10 \text{ mA}$
- High Intensity Spot Light for Back Lighting a Transparent Panel
- Illuminates a 1/4" Diameter Circle
- One Inch Leads
- IC Compatible
- Versatile Mounting on P.C. Board
- Snap in Mounting Clip for Panel Mounting
- Replacement for MV5054-1/MV5054-2

DESCRIPTION

The RL-5054-1/RL-5054-2 is a very bright Gallium Arsenide Phosphide solid state lamp in a red epoxy package that is designed to illuminate a 1/4" circle. Its high intensity narrow on axis beam is ideal for back lighting applications. It is not recommended for general purpose front panel installation where the wide angle RL-4403 is particularly well suited.

Package Dimensions in Inches

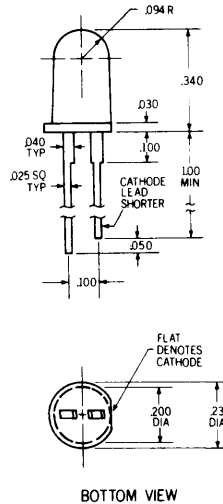

Maximum Ratings

Power Dissipation @ 25°C Ambient	200 mW
Derate Linearly from 25°C	-2.67 mW/°C
Continuous Forward Current	100 mA
Storage and Operating Temperature	-55°C to +100°C
Lead Soldering Temperature (1/16 in. from case)	.5 sec @ 260°C
Peak Inverse Voltage	3V

Opto-Electronic Characteristics (at 25°C)

Parameter	Min	Typ	Max	Unit	Test Condition
Luminous Intensity					
RL-5054-1	1	2		mcd	$I_F = 10 \text{ mA}$
RL-5054-2	2	2.5		mcd	$I_F = 10 \text{ mA}$
Emission Peak Wavelength		650		nm	
Spectral Line Half-Width		40		nm	
Forward Voltage		1.6	2.0	V	$I_F = 20 \text{ mA}$
Reverse Leakage		0.1	10	μA	$V_R = 3V$
Capacitance		35		pF	$V = 0$
Rise and Fall Time		50		ns	50Ω System
Viewing Angle (Total)		24		deg.	Between 50% Intensity Points
Illumination (Circle Dia.)		.250		in.	Measured From End of Lens

Specifications subject to change without notice.

TYPICAL OPTO-ELECTRONIC CHARACTERISTIC CURVES

**LUMINOUS INTENSITY VS
AMBIENT TEMPERATURE**

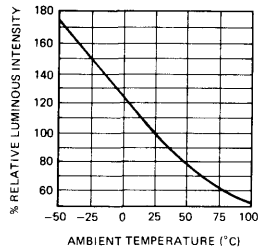

**SPECTRAL
DISTRIBUTION**

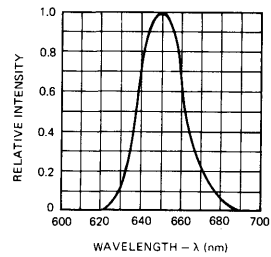

**LUMINOUS INTENSITY VS
FORWARD CURRENT**

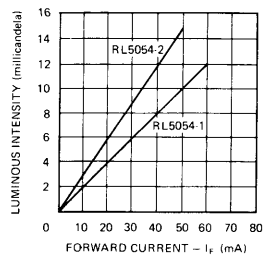

Mounting Information

The clip mounts in a .250" dia. hole and fits up to .125" panel thickness. A plastic collar is provided which fits over the back of the clip to lock the LED securely against the panel.

BLACK CLIP AND COLLAR: 004-9002

CLEAR CLIP AND COLLAR: 004-9003

YELLOW T1 3/4 LED LAMPS

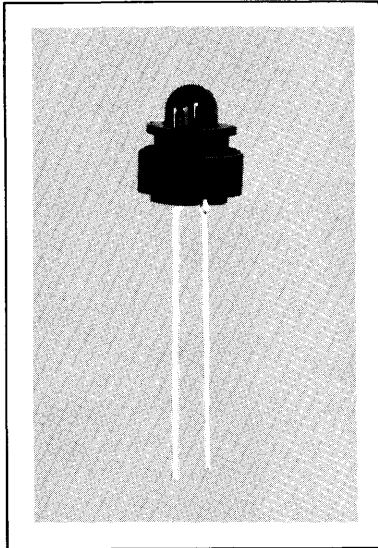

FEATURES

- T1 3/4 Package Size
- 1 Inch Leads
- Both Types Can Be Front Panel Mounted
- Snap In Mounting Clips Available
- IC Compatible

DESCRIPTION

Both types are TSN (Transparent Substrate Nitrogen) LED lamps with yellow diffused lens. The YL-4850 is a low price commercial grade device. The YL-4550 is a higher brightness lamp.

Package Dimensions in Inches

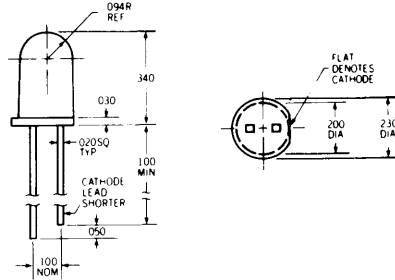

Maximum Ratings

Power Dissipation @ 25 °C	120 mW
Derate Linearly from 25 °C	- 1.6 mW/°C
Storage & Operating Temperature	-55 °C to +100 °C
Lead Soldering Temperature (1/16 in. from case)	5 sec @ 260 °C
Peak Inverse Voltage	3.0 V/5.0 V
Continuous Forward Current	30 mA

Opto-Electronic Characteristics (@ 25 °C)

Parameter	Min	Typ	Max	Unit	Test Condition
Luminous Intensity					
YL-4850	.05	2.0		mcd	I _F = 20 mA
YL-4550	1.0	1.8		mcd	I _F = 10 mA
Emission Peak Wavelength		585		nm	
Spectral Line Half-Width		35		nm	
Forward Voltage		2.4	3.5	V	I _F = 20 mA
Reverse Leakage					
YL-4850		0.1	100	μA	V _R = 3.0 V
YL-4550		0.1	100	μA	V _R = 5.0 V

Specifications subject to change without notice.

TYPICAL OPTO-ELECTRONIC CHARACTERISTIC CURVES

RELATIVE LUMINOUS INTENSITY VS ANGLE

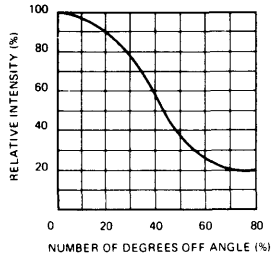

RELATIVE LUMINOUS INTENSITY VS FORWARD CURRENT

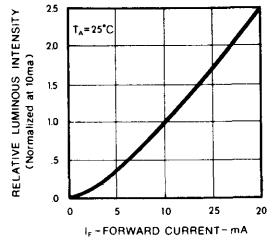

FORWARD CURRENT VS FORWARD VOLTAGE

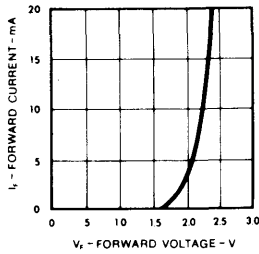

SPECTRAL DISTRIBUTION

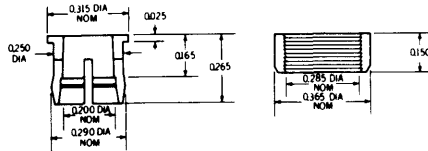
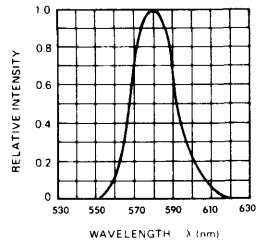

Mounting Information: YL-4850 and YL-4550

The clip mounts in a .250" dia. hole and fits up to .125" panel thickness. A plastic collar is provided which fits over the back of the clip to lock the LED securely against the panel.

BLACK CLIP AND COLLAR : 004-9002

CLEAR CLIP AND COLLAR : 004-9003

GREEN T1^{3/4} LED LAMP

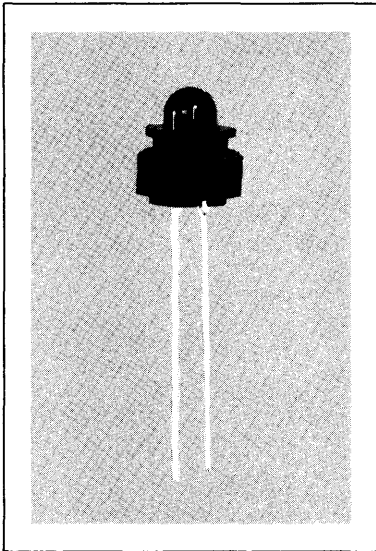

FEATURES

- T1^{3/4} — Package Size
- 1 Inch Leads
- Both Types Can Be Front Panel Mounted
- Snap In Mounting Clips Available
- IC Compatible

DESCRIPTION

Both types are green gallium phosphide solid state lamps with green diffused lens. The GL-4850 is a low price commercial grade device. The GL-4950 is a higher brightness lamp with minimum light output specified.

Package Dimensions in Inches

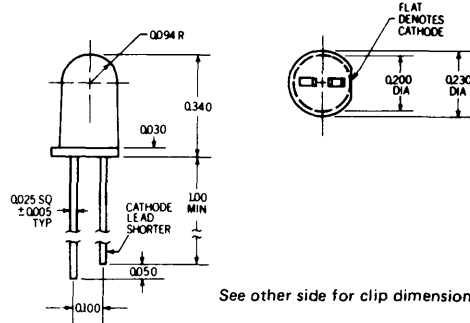

See other side for clip dimensions.

Maximum Ratings

- Power Dissipation @ 25 °C 120 mW
- Derate Linearly from 25 °C -2.2 mW/°C
- Storage & Operating Temperature -40 °C to +80 °C
- Lead Soldering Temperature
(1/16 in. from case) 5 sec @ 260 °C
- Peak Inverse Voltage 3.0 V/5.0 V
- Continuous Forward Current 30 mA

Opto-Electronic Characteristics (@ 25 °C)

Parameter	Test			Unit	Condition
	Min	Typ	Max		
Luminous Intensity					
GL-4850		1.0		mcd	I _F = 20 mA
GL-4950	1.0	1.8		mcd	I _F = 20 mA
Emission Peak Wavelength		565		nm	
Spectral Line Half-Width		35		nm	
Forward Voltage		2.2	3.0	V	I _F = 20 mA
Reverse Leakage					
GL-4850		0.1	100	μA	V _R = 3.0 V
GL-4950			100	μA	V _R = 5.0 V

Specifications subject to change without notice.

TYPICAL OPTO-ELECTRONIC CHARACTERISTIC CURVES.

RELATIVE LUMINOUS INTENSITY VS ANGLE

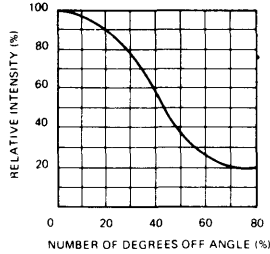

RELATIVE LUMINOUS INTENSITY VS FORWARD CURRENT

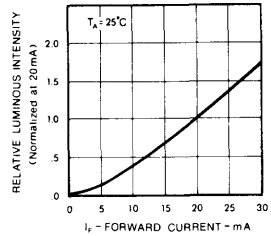

FORWARD CURRENT VS FORWARD VOLTAGE

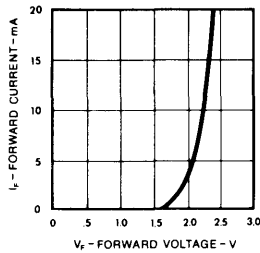

SPECTRAL DISTRIBUTION

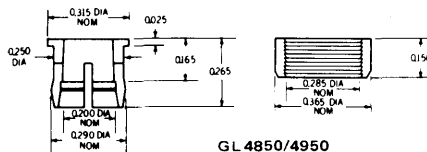
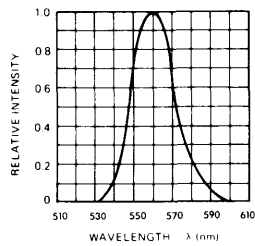

GL 4850/4950

Mounting Information: GL-4850 and GL-4950

The clip mounts in a .250" dia. hole and fits up to .125" panel thickness. A plastic collar is provided which fits over the back of the clip to lock the LED securely against the panel.

BLACK CLIP AND COLLAR: 004-9002

CLEAR CLIP AND COLLAR: 004-9003

RL-209 SERIES RL-4484

RED T1 LED LAMPS

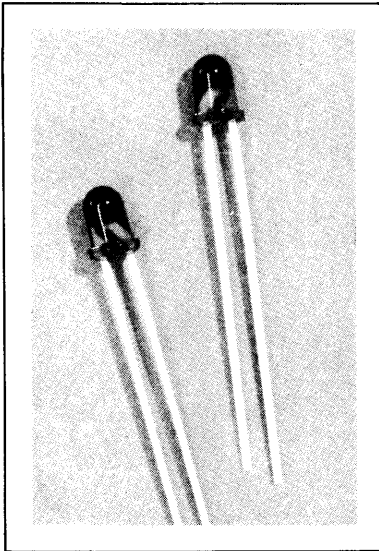

Package Dimensions in Inches (mm)

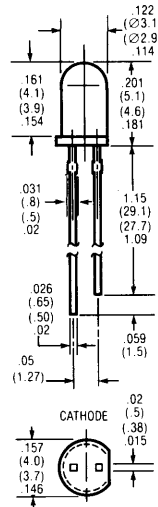

NOTE: Lead spacing on the RL-209 and RL-4484 was formerly 75 mils. If wider lead spacing on a T1 size lamp is required, refer to RL-4480 with 100 mil lead spacing.

FEATURES

- Miniature T1 Size
- One Inch Leads
- 50 Mil Lead Spacing
- Brightness Categories, RL-209
- Low Power Consumption
- IC Compatible
- Economical Molded Plastic Package
- Mounting Clip Available

DESCRIPTION

The Red-Lit 209 series is intended for high volume usage in array and indicator light applications requiring long life at low cost. This series offers brightness categories for easy selection and assembly.

Maximum Ratings

Power Dissipation @ 25°C Ambient	80 mW
Derate Linearly From 25°C	-1.1 mW/°C
Storage and Operating Temperature	-55°C to 100°C
Continuous Forward Current	40 mA
Peak Inverse Voltage	3.0V

Opto-Electronic Characteristics (@ 25 °C)

Parameter	Min	Typ	Max	Unit	Test Condition
Reverse Current		100		nA	V _R = 3.0 V
Forward Voltage		1.6	2.0	V	I _F = 20 mA
Luminous Intensity				mcd	I _F = 20 mA
RL-4484		0.8			I _F = 20 mA
RL-209A	0.5	0.8			I _F = 20 mA
RL-209-1	1.0	1.5	2.0		I _F = 20 mA
RL-209-2	2.0	2.4			I _F = 20 mA
Emission Peak Wavelength		650		nm	

Specifications subject to change without notice.

TYPICAL OPTO-ELECTRONIC CHARACTERISTIC CURVES

FIGURE 1. FORWARD CHARACTERISTICS

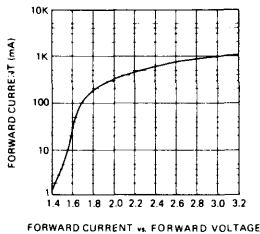

FIGURE 2. LUMINANCE vs T_J

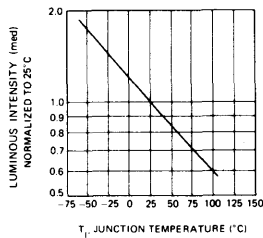

FIGURE 3. LUMINANCE vs FORWARD CURRENT

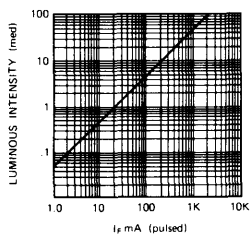
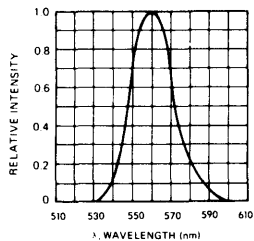

FIGURE 4. SPECTRAL DISTRIBUTION



The effect of junction heating is not reflected in figure 3 as pulse width and duty cycle were limited to prevent heating effects. However, junction heating can cause reduction in luminance as evidenced in figure 2. To estimate output level, average junction temperature may be calculated from

$$T_{J(AV)} = T_A + \theta_{JA} V_F I_F D$$

Where D is the duty cycle of the applied current I_F, $\theta_{JA} = 350^\circ\text{C/W}$ (max). This calculation should be limited to pulse durations of less than 10 ms to avoid errors caused by high peak junction temperature.

Clip Mounting Information

The clip mounts in a .203" dia. hole and fits a .062" panel thickness.

BLACK CLIP: 004-9011

YELLOW T1 LED LAMPS

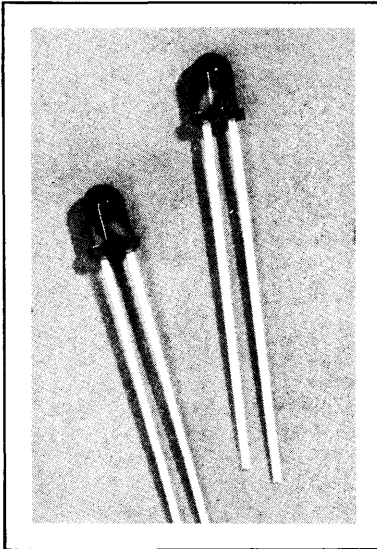

FEATURES

- T1 Package Size
- 1 Inch Leads
- Both Types Can Be Front Panel Mounted
- Snap In Mounting Clips Available
- IC Compatible

DESCRIPTION

Both types are TSN (Transparent Substrate Nitrogen) LED lamps with yellow diffused lens. The YL-4484 is a low price commercial grade device. The YL-212 is a higher brightness lamp with minimum light output specified.

Package Dimensions in Inches

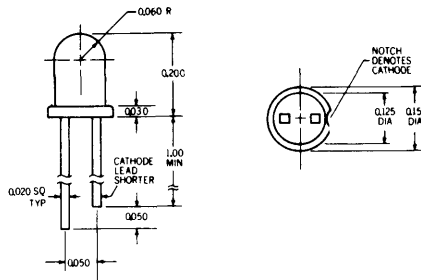

Maximum Ratings

- Power Dissipation @ 25 °C 120 mW
- Derate Linearly from 25 °C -1.6 mW/°C
- Storage & Operating Temperature -55 °C to +100 °C
- Lead Soldering Temperature
(1/16 in. from case) 5 sec @ 260 °C
- Peak Inverse Voltage 5.0 V/3.0 V
- Continuous Forward Current 30 mA

Opto-Electronic Characteristics (@ 25 °C)

Parameter	Min	Typ	Max	Unit	Test Condition	
					I _F	V _R
Luminous Intensity						
YL-4484	.05	2.0		mcd	I _F = 20 mA	
YL-212	1.0	1.8		mcd	I _F = 10 mA	
Emission Peak Wavelength		585		nm		
Spectral Line Half-Width		35		nm		
Forward Voltage		2.4	3.5	V	I _F = 20 mA	
Reverse Leakage						
YL-4484		0.1	100	μA	V _R = 3.0 V	
YL-212		0.1	100	μA	V _R = 5.0 V	

Specifications subject to change without notice.

TYPICAL OPTO-ELECTRONIC CHARACTERISTIC CURVES

RELATIVE LUMINOUS INTENSITY VS ANGLE

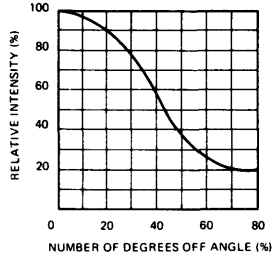

RELATIVE LUMINOUS INTENSITY VS FORWARD CURRENT

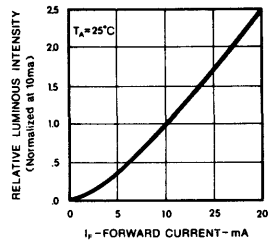

FORWARD CURRENT VS FORWARD VOLTAGE

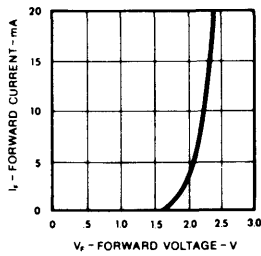

SPECTRAL DISTRIBUTION

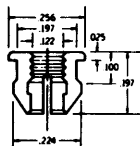
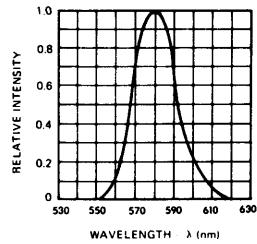

Mounting Information; YL-212 and YL-4484

The clip mounts in a .203" dia. hole and fits a .062" panel thickness.

BLACK CLIP: 004-9011

GREEN T1 LED LAMP

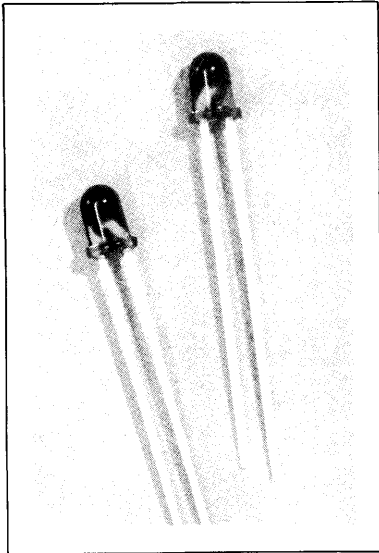

FEATURES

- T1 Package Size
- 1 Inch Leads
- Both Types Can Be Front Panel Mounted
- Snap In Mounting Clips Available
- IC Compatible

DESCRIPTION

Both types are green gallium phosphide solid state lamps with green diffused lens. The GL-4484 is a low price commercial grade device. The GL-211 is a higher brightness lamp with minimum light output specified.

Package Dimensions in Inches

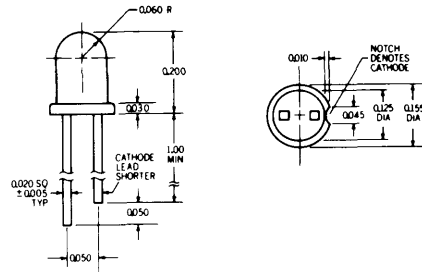

See other side for clip dimensions.

Maximum Ratings

Power Dissipation @ 25°C	120 mW
Derate Linearly from 25°C	-2.2 mW/°C
Storage & Operating Temperature	-55°C to 100°C
Lead Soldering Temperature (1/16 in. from case)	5 sec @ 260°C
Peak Inverse Voltage	3.0 V
Continuous Forward Current	30 mA

Opto-Electronic Characteristics (@ 25°C)

Parameter	Min	Typ	Max	Unit	Test Condition	
Luminous Intensity						
GL-4484		1.0		mcd	$I_F = 20$ mA	
GL-211	0.8	1.5		mcd	$I_F = 10$ mA	
Emission Peak Wavelength		565		nm		
Spectral Line Half-Width		35		nm		
Forward Voltage		2.2	3.0	V	$I_F = 20$ mA	
Reverse Leakage		0.1	100	μ A	$V_R = 3.0$ V	
			100	μ A	$V_R = 5.0$ V	

Specifications subject to change without notice.

TYPICAL OPTO-ELECTRONIC CHARACTERISTIC CURVES.

RELATIVE LUMINOUS INTENSITY VS ANGLE

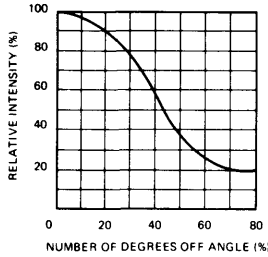

RELATIVE LUMINOUS INTENSITY VS FORWARD CURRENT

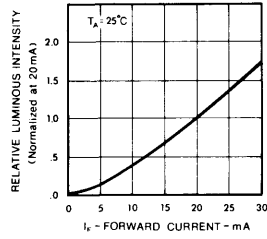

FORWARD CURRENT VS FORWARD VOLTAGE

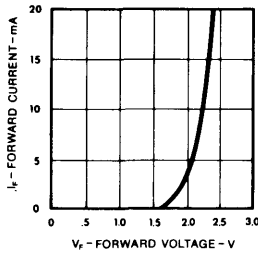

SPECTRAL DISTRIBUTION

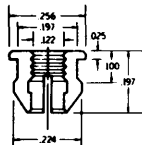
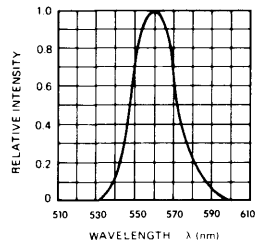

Mounting Information: GL-211 and GL-4484

The clip mounts in a .203" dia. hole and fits a .062" panel thickness.

BLACK CLIP: 004-9011

RED MINIATURE AXIAL LEAD LED LAMP

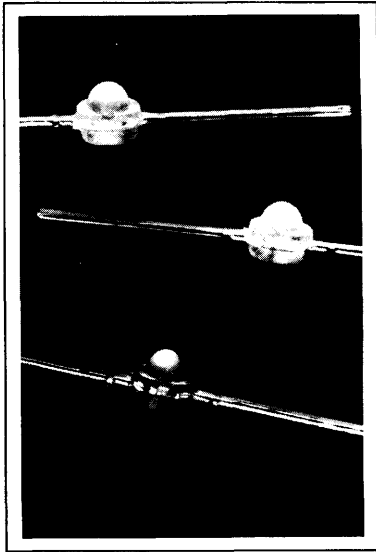

Package Dimensions in Inches

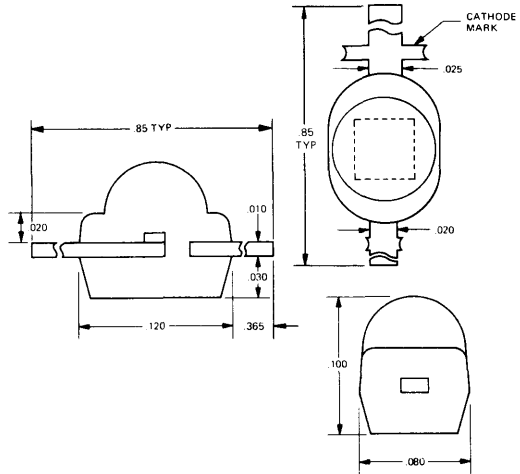

FEATURES

- High Luminance — Typically 0.8 mcd
- Optimum Packaging Design for Maximum Strength at Minimum Linear Spacing
- Operates from 5 V IC Logic Supply
- Small Size
- High Reliability

DESCRIPTION

The RL-50 is intended for high volume usage in array and indicator light applications. Major advantages of this device are high luminance at lower currents, long life and low cost.

Note:

- RL-50 Water Clear Lens
- RL-50-01 Red Diffused Lens
- RL-50-02 Red Clear Lens

Maximum Ratings

Power Dissipation @ 25°C Ambient	80 mW
Derate Linearly From 25°C	-1.1 mW/°C
Storage and Operating Temp Range	-55 to 100°C
Continuous Forward Current	40 mA
Peak Inverse Voltage	3.0 V

Opto-Electronic Characteristics (@ 25°C)

Parameter	Min	Typ	Max	Unit	Test Condition
Reverse Current		100		μA	-3.0 V
Forward Voltage		1.6	2.0	V	I _F = 20 mA
Luminous Intensity	0.3	0.8		mcd	I _F = 20 mA
Light Rise and Fall Time		1.0		ns	

Specifications subject to change without notice.

TYPICAL OPTO-ELECTRONIC CHARACTERISTIC CURVES

FIGURE 1. FORWARD CHARACTERISTICS

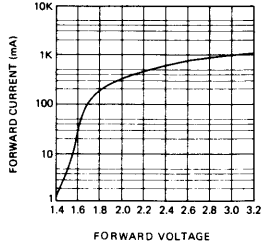

FIGURE 2. LUMINANCE VS T_J

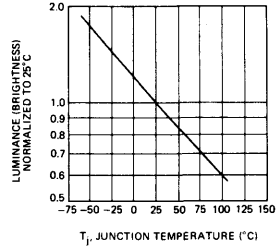
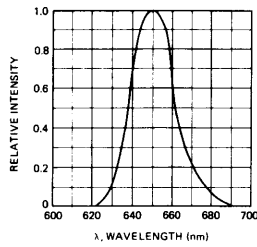
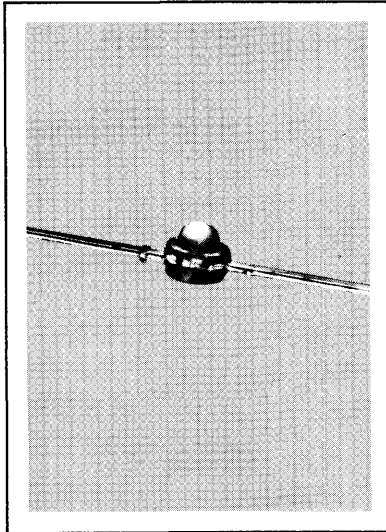

FIGURE 3. SPECTRAL DISTRIBUTION



RED MINIATURE AXIAL LEAD LED LAMP



Package Dimensions in Inches

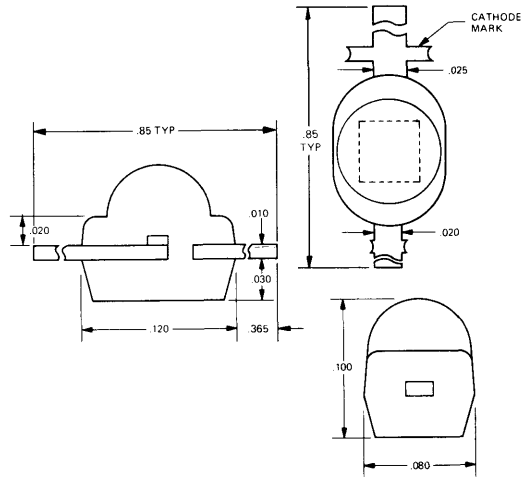

FEATURES

- Low Cost
- Optimum Packaging Design For Maximum Strength at Minimum Linear Spacing
- Operates From 5V IC Logic Supply
- Small Size
- High Reliability
- Red Diffused Lens

DESCRIPTION

The Red-Lit 54 is intended for high volume usage in array and indicator light applications. Major advantages of this device are high luminance at lower currents, long life and low cost.

Maximum Ratings

Power Dissipation @25°C Ambient	80 mW
Derate Linearly from 25°C	-1.1 mW/°C
Storage & Operating Temp. Range	-40°C to +80°C
Continuous Forward Current	40 mA
Peak Inverse Voltage	3.0 V

Opto-Electronic Characteristics (@25°C)

Parameter	Min	Typ	Max	Test
				Conditions
Reverse Current		100		μA@ -3.0 V
Forward Voltage		1.6	2.0	V@ I _F = 20 mA
Brightness	0.05	0.8		mcd@ I _F = 20 mA
Light Rise and Fall Time		1.0		ns

Specifications subject to change without notice.

RED MINIATURE AXIAL LEAD LED LAMP

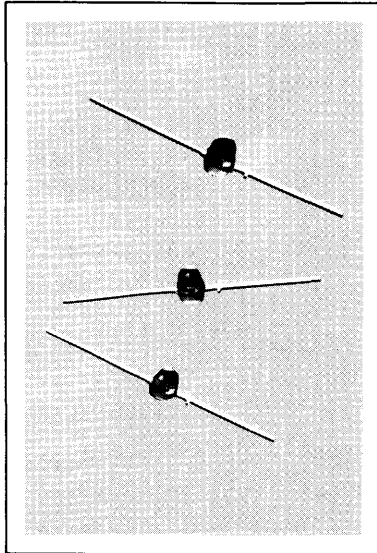

Package Dimensions in Inches

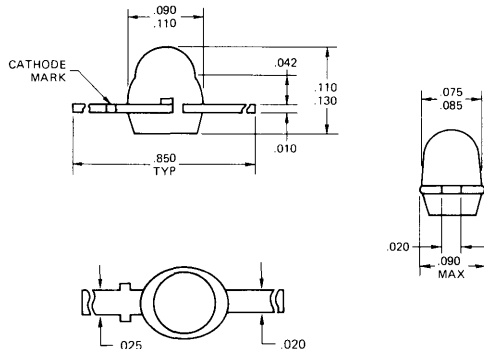

FEATURES

- 2 Gate Load Bright Light — .4 mcd at 3 mA
- High on Axis Intensity — 3 mcd at 20 mA
- Optimum Packaging Design for Maximum Strength at Minimum Linear Spacing
- Operates from 5 V IC Logic Supply
- Miniature Axial Lead
- High Reliability
- RL-55-5 — Low Cost Version

DESCRIPTION

The RL-55 is a Gallium Arsenide Phosphide LED lamp that has high on axis intensity at low current (3 mA), long life and low cost. It uses a dark red diffused lens and provides a full .080" flooded light with good contrast. When operated at high current (20 mA) the RL-55 has a very high on axis intensity of 3 mcd. Applications include mounting on P.C. boards at low current as diagnostic and circuit status indicators. Function and low voltage indicator on battery powered equipment such as calculators, watches and portable DVM's and in the higher current mode as a back light.

Maximum Ratings

Power Dissipation @ 25°C Ambient	80 mW
Derate Linearly From 25°C	-1.1 mW/°C
Storage and Operating Temperature	-55°C to +100°C
Continuous Forward Current	40 mA
Lead Solder Time @ 260°C (1/16" from case)	5 sec
Peak Inverse Voltage	3V
Peak Forward Current (1μs pulse, 0.1% duty cycle)	400 mA

Opto-Electronic Characteristics (@ 25°C)

Parameter	Min	Typ	Max	Unit	Test
					Condition
Reverse Current			10	μA	V _R = 3 V
Forward Voltage		1.6	2.0	V	I _F = 20 mA
Luminous Intensity					
RL-55	2	3		mcd	I _F = 20 mA
RL-55-5	0.8	1.5		mcd	I _F = 20 mA
Capacitance		20		pF	V = 0
Light Rise and Fall Time		1.0		ns	
Peak Emission Wavelength		650		nm	
Spectral Line Half-Width		40		nm	

Specifications subject to change without notice.

TYPICAL OPTO-ELECTRONIC CHARACTERISTIC CURVES RL-55

(25°C Free Air Temperature Unless Otherwise Specified)

FIGURE 1. RADIATED POWER

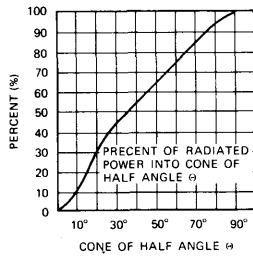

FIGURE 2. RADIATION INTENSITY VS. ANGLE

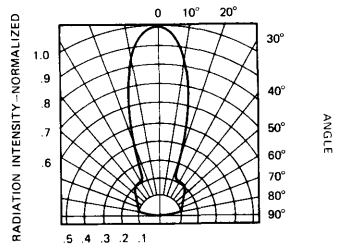
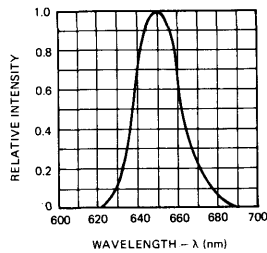
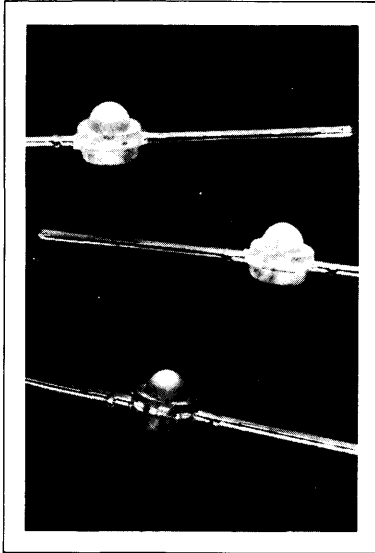

FIGURE 3. SPECTRAL DISTRIBUTION



MINIATURE AXIAL LEAD LED LAMP



FEATURES

- High on Axis Intensity
- Optimum Packaging Design for Maximum Strength at Minimum Linear Spacing
- Operates from 5 V IC Logic Supply
- Miniature Axial Lead
- High Reliability

DESCRIPTION

The GL-56/YL-56 are Gallium Phosphide LED lamps that have high on axis intensity, long life and low cost. They use diffused lenses and provide a full 0.080" flooded light with good contrast. When operated at high current (20 mA) they have high on axis intensity. Applications include mounting on P.C. boards at low current as diagnostic and circuit status indicators.

Package Dimensions in Inches (mm)

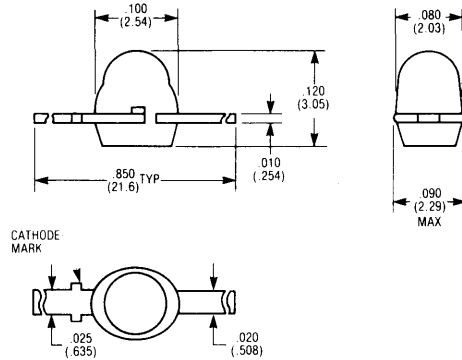

Maximum Ratings

Power Dissipation @ 25°C Ambient	80 mW
Derate Linearly From 25°C	-1.1 mW/°C
Storage and Operating Temperature	-55°C to +100°C
Continuous Forward Current	22 mA
Lead Solder Time @ 260°C (1/16" from case)	5 sec
Peak Inverse Voltage	3V
Peak Forward Current (1µs pulse, 0.1% duty cycle)	250 mA

Opto-Electronic Characteristics (@ 25°C)

Parameter	Min	Typ	Max	Units	Test Condition	
					I _F	V _R
Luminous Intensity				mcd		
YL-56	.05	2.0			20 mA	
GL-56	.05	1.0			20 mA	
Forward Voltage				V		
YL-56		2.4	3.5		20 mA	
GL-56		2.2	3.5		20 mA	
Reverse Current		0.15		µA		3 V
Peak Emission Wavelength				nm		
YL-56		585				
GL-56		565				

Specifications subject to change without notice.

RED T1 3/4 FLASHING LED LAMP

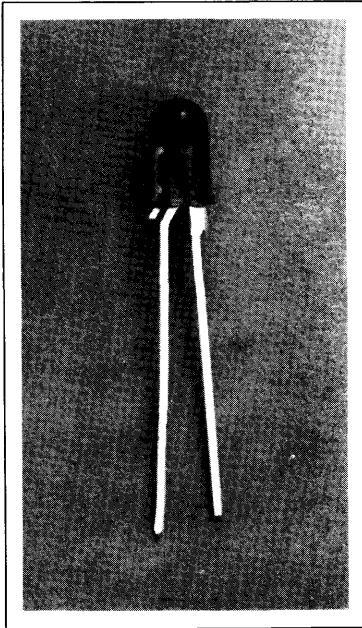

Physical Dimensions in Inches (mm)

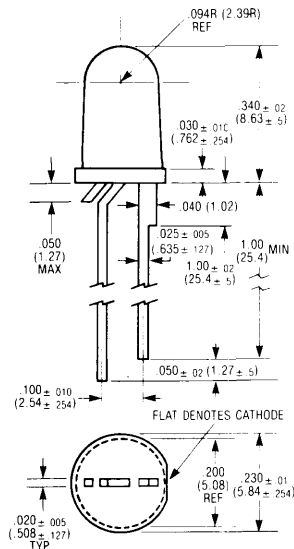

FEATURES

- Built-in IC Chip, Flashes Lamp On and Off to Attract Attention
- Pulse Rate — 2.5 Hz
- T1 3/4 Size
- Large Full Flood Radiating Area
- 1.2 mcd @ V_F = 5 V
- IC Compatible

DESCRIPTION

The FRL-2000 is a gallium arsenide phosphide solid state lamp with a red diffused plastic lens. The built-in IC flashes the lamp on/off and can be driven directly by standard TTL and CMOS circuits, eliminating the need for external switching circuitry.

Maximum Ratings

Operating Temperature	0 to 70 °C
Storage Temperature	- 20 to + 100 °C
Lead Soldering Temperature (1/16 in. from case)	5 sec @ 260 °C
Operating Voltage	7 V
Peak Inverse Voltage	0.4 V

Opto-Electronic Characteristics (@ 25 °C)

Parameter	Min	Typ	Max	Unit	Test Condition
Luminous Intensity	0.8	1.2		mcd	V _F = 5 V
Emission Peak Wavelength		650		nm	
Spectral Line Half-Width		40		nm	
Operating Voltage	4.75	5.0	5.25	V	
Peak Current (50% Duty Cycle)		20	35	mA	V _F = 5 V
Pulse Rate	1.5	2.5	4.5	Hz	V _F = 5 V
Pulse Rate (0 °C to 70 °C)	1.0		5.8	Hz	V _F = 5 V

Specifications subject to change without notice.

TYPICAL OPERATING CHARACTERISTICS

FREQUENCY VS VOLTAGE

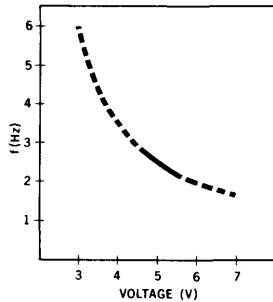

CURRENT VS VOLTAGE

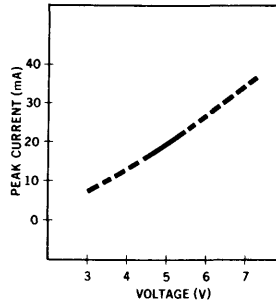

TYPICAL APPLICATIONS

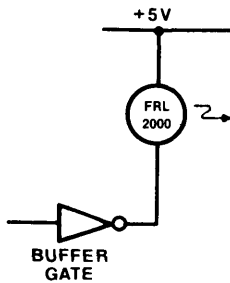

DRIVEN BY TTL OR MOS BUFFER GATE

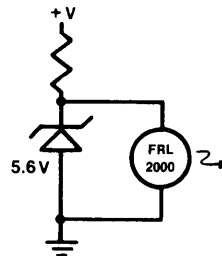

FOR OPERATION AT GREATER THAN 5 VOLTS

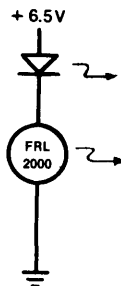

TYPICAL CIRCUIT
TWO LEDs
FLASHING TOGETHER

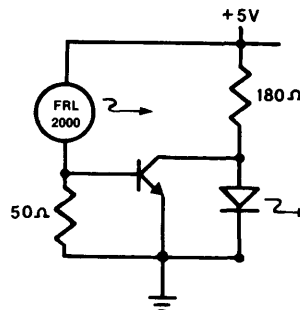

TYPICAL CIRCUIT
TWO LEDs
FLASHING ALTERNATELY

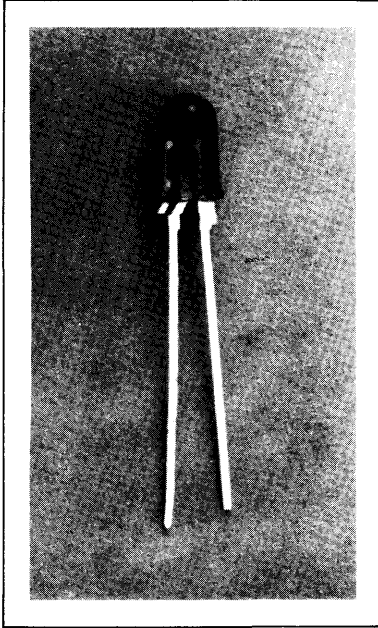

Package Dimensions in Inches

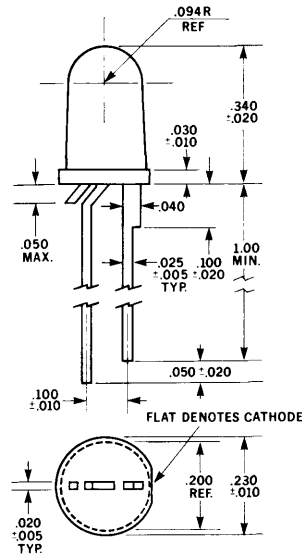

FEATURES

- Built-in IC chip, flashes lamp on and off to attract attention.
- Pulse rate – 2.5 Hz
- T1 ¼ size
- 1-Inch Leads
- Large full flood radiating area
- 0.5 mcd @ $V_F = 5V$
- IC compatible

DESCRIPTION

The FRL-4403 is a gallium arsenide phosphide solid state lamp with a red diffused plastic lens. The built-in IC flashes the lamp on/off and can be driven directly by standard TTL and CMOS circuits, eliminating the need for external switching circuitry.

Maximum Ratings

- Operating Temperature. 0°C to 70°C
- Storage Temperature -20°C to +85°C
- Lead Soldering Temperature. 5 sec @ 260°C (1/16 inch from case)
- Operating Voltage. 7V
- Peak Inverse Voltage 0.4V

Opto-Electronic Characteristics (@ 25°C)

Parameter	Min	Typ	Max	Unit	Test Conditions
Luminous Intensity.	0.5	1.2		mcd	$V_F = 5V$
Emission Peak Wavelength		650		nm	
Spectral Line Half-Width		40		nm	
Operating Voltage.	4.75	5.0	5.25	V	
Peak Current. (50% duty cycle)		20	35	mA	$V_F = 5V$
Pulse Rate	1.5	2.5	4.5	Hz	$V_F = 5V$
Pulse Rate (0°C to 70°C)	1.0	—	5.8	Hz	$V_F = 5V$

Specifications subject to change without notice

TYPICAL OPERATING CHARACTERISTICS FRL-4403

FREQUENCY VS VOLTAGE

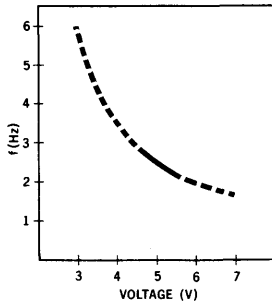

CURRENT VS VOLTAGE

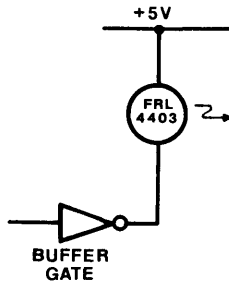
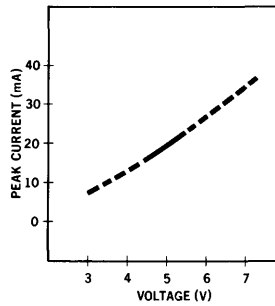

DRIVEN BY TTL OR MOS BUFFER GATE

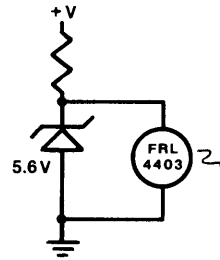

FOR OPERATION AT GREATER THAN 5 VOLTS

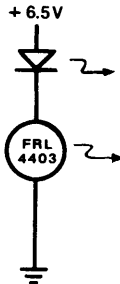

TYPICAL CIRCUIT TWO LED'S FLASHING TOGETHER

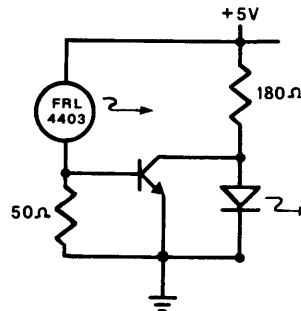

TYPICAL CIRCUIT TWO LED'S FLASHING ALTERNATELY

RED T1 3/4 CURRENT REGULATED LED LAMP

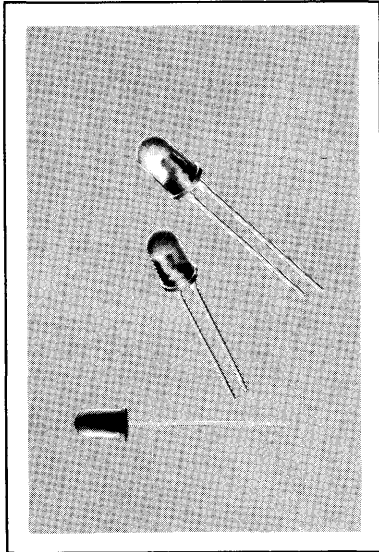

FEATURES

- T1 3/4 Size
- 1 Inch Leads
- Constant intensity from 4.5 V to 12.5 V
- 20 mA typical forward current
- 1.2 mcd typical at $V_F = 6.0$ V
- No resistor needed to operate up to 12.5 V
- Front panel mounting
- Large full flood radiating area
- IC compatible
- Snap in mounting clip available
- Red diffused lens

DESCRIPTION

The RLC 200 is a high brightness Gallium Arsenide Phosphide solid state lamp containing a current regulating integrated circuit that provides a constant intensity over a wide voltage range. The unit has a large full flooded front radiating area for wide angle viewing and can be easily soldered directly to a PC board or mounted in a panel with a snap in mounting clip.

Package Dimensions In Inches

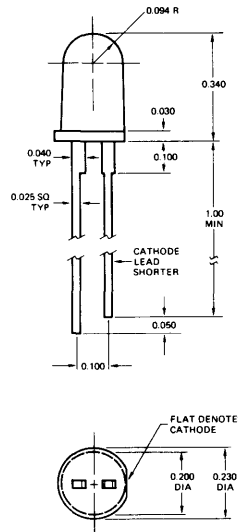

BOTTOM VIEW

Maximum Ratings

Power dissipation @ 25°C	300mW
Derate voltage linearly from 25°C	-0.125V/°C
Forward voltage @ 25°C	12.5V
Storage and operating temperature	-55 to +100°C
Lead soldering temperature (1/16 inch from case)	5 sec. @ 260°C
Peak inverse voltage	3.0V

Optoelectronic Characteristics (at 25°C)

Parameter	Min	Typ	Max	Unit	Test Condition
Luminous intensity	0.8	1.2		mcd	$V_F = 6V$
Forward current	14	20	24	mA	$V_F = 12.5V$
Emission peak wavelength		650		nm	
Spectral line half width		40		nm	
Reverse leakage		0.1	100	μA	$V_R = 3.0V$

Specifications subject to change without notice.

FIGURE 1. RELATIVE LUMINOUS INTENSITY VS. ANGLE

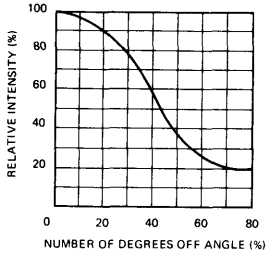

FIGURE 2. SPECTRAL DISTRIBUTION

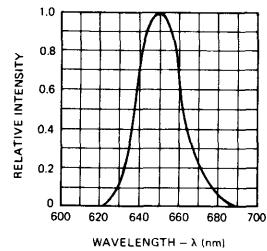

FIGURE 3. FORWARD CURRENT VS. FORWARD VOLTAGE

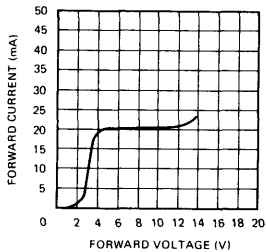
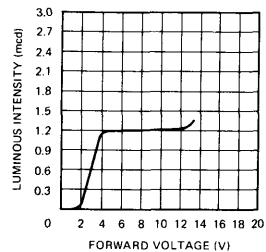

FIGURE 4. LUMINOUS INTENSITY VS. FORWARD VOLTAGE



Mounting Information

The clip mounts in a .250" dia. hole and fits up to a .125" panel thickness. A plastic collar is provided which fits over the back of the clip to lock the LED securely against the panel.

BLACK CLIP AND COLLAR: 004-9002

CLEAR CLIP AND COLLAR: 004-9003

**RED T1^{3/4} CURRENT
REGULATED LED LAMP**

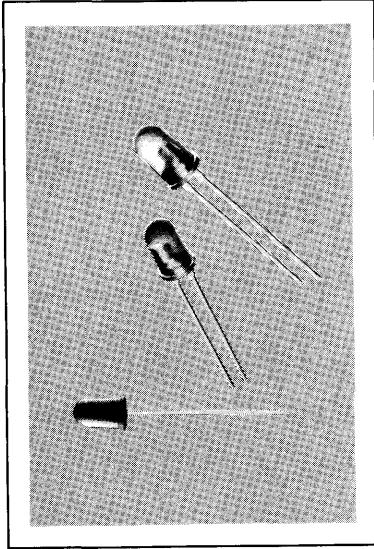

FEATURES

- T1^{3/4} size
- 1 inch leads
- Constant intensity from 4.5 V to 16 V
- 10 mA typical forward current
- 0.7 mcd typical at $V_F = 6.0$ V
- No resistor needed to operate up to 16 V
- Front panel mounting
- Large full flood radiating area
- IC compatible
- Snap in mounting clip available
- Red diffused lens

DESCRIPTION

The RLC 201 is a high brightness Gallium Arsenide Phosphide solid state lamp containing a current regulating integrated circuit that provides a constant intensity over a wide voltage range. The unit has a large full flooded front radiating area for wide angle viewing and can be easily soldered directly to a PC board or mounted in a panel with a snap in mounting clip.

Package Dimensions in Inches

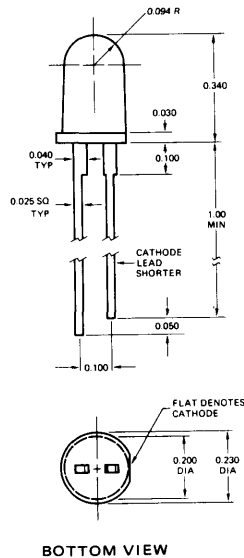

Maximum Ratings

Power dissipation @ 25°C	300mW
Derate voltage linearly from 50°C	-0.25V/°C
Forward voltage @ 25°C	16V
Storage and operating temperature	-55 to +100°C
Lead soldering temperature (1/16 inch from case)	5 sec. @ 260°C
Peak inverse voltage	3.0V

Optoelectronic Characteristics (at 25°C)

Parameter	Min	Typ	Max	Unit	Test Condition
Luminous intensity	0.4	0.7		mcd	$V_F = 6V$
Forward current	7	10	14	mA	$V_F = 16V$
Emission peak wavelength		650		nm	
Spectral line half width		40		nm	
Reverse leakage		0.1	100	μA	$V_R = 3.0V$

Specifications are subject to change without notice.

TYPICAL OPTOELECTRONIC CHARACTERISTIC CURVES

FIGURE 1. RELATIVE LUMINOUS INTENSITY VS. ANGLE

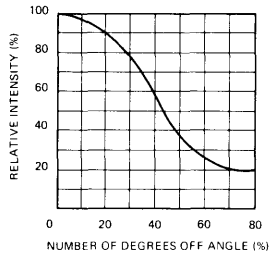

FIGURE 2. SPECTRAL DISTRIBUTION

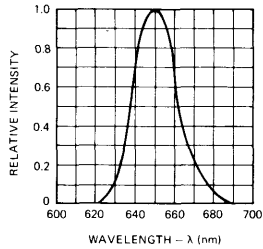

FIGURE 3. FORWARD CURRENT VS. FORWARD VOLTAGE

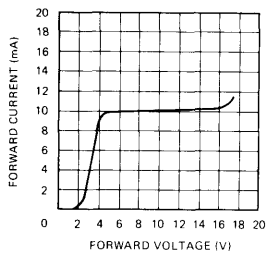
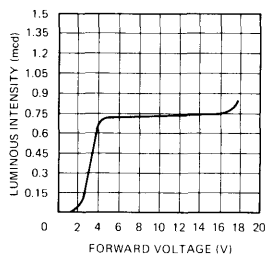

FIGURE 4. LUMINOUS INTENSITY VS. FORWARD VOLTAGE



Mounting Information

The clip mounts in a .250" dia. hole and fits up to a .125" panel thickness. A plastic collar is provided which fits over the back of the clip to lock the LED securely against the panel.

BLACK CLIP AND COLLAR: 004-9002

CLEAR CLIP AND COLLAR: 004-9003

RED T1 CURRENT REGULATED LED LAMP

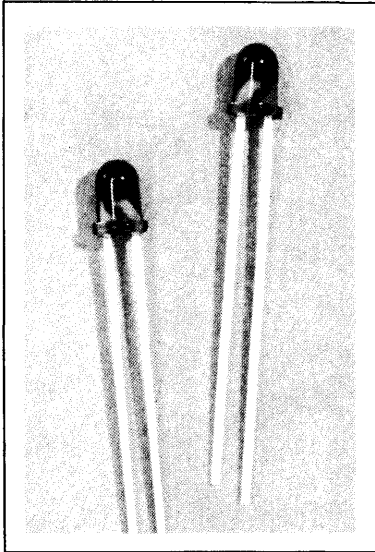

FEATURES

- T1 Size
- 1 Inch Leads
- Constant Intensity from 4.5 V to 11 V
- 10 mA Typical Forward Current
- No Resistor Needed to Operate Up to 11 V
- Miniature Size (T1 Lamp)
- Low Power Consumption
- IC Compatible
- Snap In Mounting Clip Available
- Red Diffused Lens

DESCRIPTION

The RLC 210 is a Gallium Arsenide Phosphide solid state lamp containing a current regulating integrated circuit that provides a constant intensity over a wide voltage range.

Package Dimensions in Inches

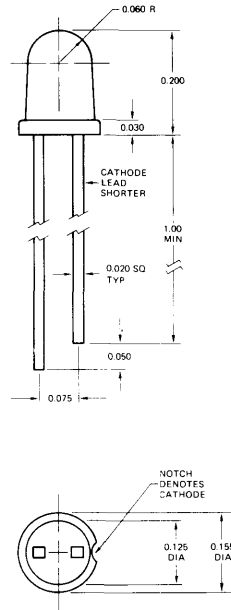

Maximum Ratings

Power dissipation @ 25°C	160mW
Derate voltage linearly from 25°C	-0.1V/°C
Forward voltage @ 25°C	11V
Storage and operating temperature	-55 to +100°C
Peak inverse voltage	3.0V

Optoelectronic Characteristics (at 25°C)

Parameter	Min	Typ	Max	Unit	Test Condition
Luminous intensity	0.1	0.6		mcd	V _F = 6V
Forward current	7	10	14	mA	V _F = 11V
Emission peak wavelength		650		nm	
Spectral line half width		40		nm	
Reverse leakage		0.1	10	μA	V _R = 3.0V

Specifications subject to change without notice.

TYPICAL OPTOELECTRONIC CHARACTERISTIC CURVES

FIGURE 1. FORWARD CURRENT VS. FORWARD VOLTAGE

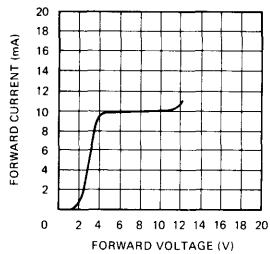

FIGURE 2. LUMINOUS INTENSITY VS. FORWARD VOLTAGE

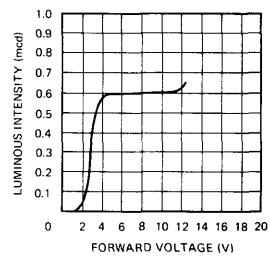
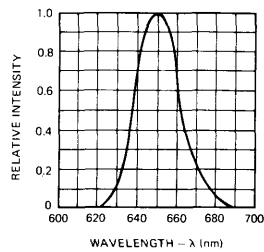

FIGURE 3. SPECTRAL DISTRIBUTION



Clip Mounting Information

The clip mounts in a .203" dia. hole and fits a .062" panel thickness.
BLACK CLIP: 004-9011

OPTO-COUPPLERS

IL-1 SINGLE CHANNEL ILD-1 DUAL CHANNEL ILQ-1 QUAD CHANNEL

PHOTOTRANSISTOR
OPTO-ISOLATOR

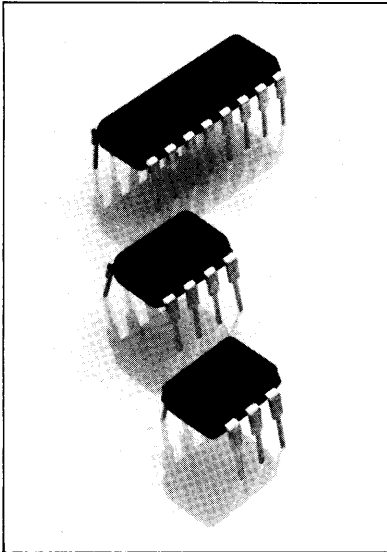

FEATURES

- 7400 Series T²L Compatible
- 2500 Volt Breakdown Voltage
- 0.5 pF Coupling Capacitance
- Industry Standard Dual-In-Line Package
- Single Channel, Dual, and Quad Configurations
- Underwriters Lab Approval #E52744

DESCRIPTION

IL-1 is an optically coupled pair employing a Gallium Arsenide infrared LED and a silicon NPN phototransistor. Signal information, including a DC level, can be transmitted by the device while maintaining a high degree of electrical isolation between input and output. The IL-1 is especially designed for driving medium-speed logic, where it may be used to eliminate troublesome ground loop and noise problems. It can also be used to replace relays and transformers in many digital interface applications, as well as analog applications such as CRT modulation. The ILD-1 offers two isolated channels in a single DIP package while the ILQ-1 provides four isolated channels per package.

Package Dimensions in Inches (mm)

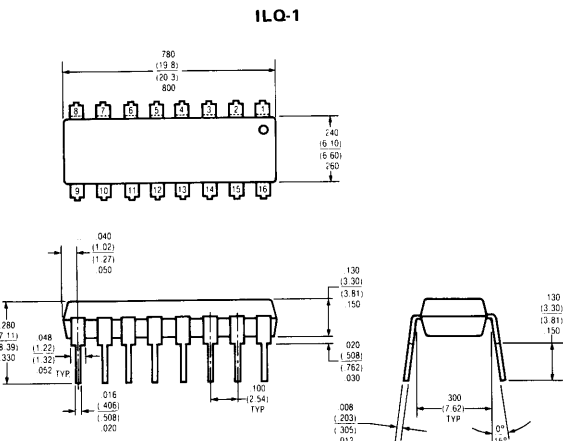
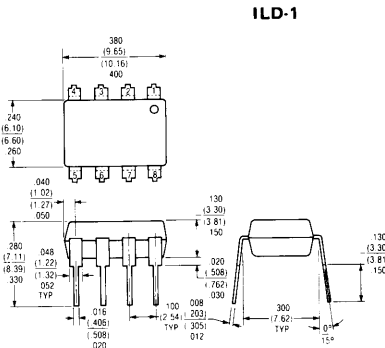
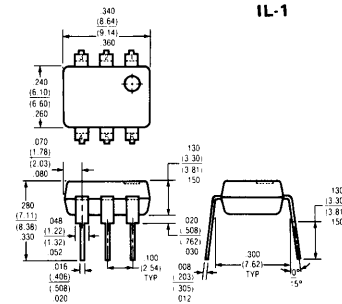

Specifications subject to change without notice.

MAXIMUM RATINGS

Gallium Arsenide LED (each channel)

Power Dissipation @ 25°C	
IL-1	200 mW
ILD-1	150 mW
ILQ-1	150 mW
Derate Linearly from 25°C	
IL-1	2.6 mW/°C
ILD-1	1.33 mW/°C
ILQ-1	1.33 mW/°C
Continuous Forward Current	
IL-1	100 mA
ILD-1	100 mA
ILQ-1	100 mA
Detector Silicon Phototransistor (each channel)	
Power Dissipation @ 25°C	
IL-1	200 mW
ILD-1	150 mW
ILQ-1	150 mW
Derate Linearly from 25°C	
IL-1	2.6 mW/°C
ILD-1	2.0 mW/°C
ILQ-1	2.0 mW/°C
Collector-Emitter Breakdown Voltage	30 V
Emitter-Collector Breakdown Voltage	7 V
Collector-Base Breakdown Voltage (IL-1)	70 V
Package	
Total Package Dissipation at 25°C Ambient (LED Plus Detector)	
IL-1	250 mW
ILD-1	400 mW
ILQ-1	500 mW
Derate Linearly from 25°C	
IL-1	3.3 mW/°C
ILD-1	5.33 mW/°C
ILQ-1	6.67 mW/°C
Storage Temperature	-55°C to +150°C
Operating Temperature	-55°C to +100°C
Lead Soldering Time @ 260°C	10 sec

ELECTRICAL CHARACTERISTICS PER CHANNEL (at 25°C Ambient)

Parameter	Min	Typ	Max	Units	Test Conditions
Gallium Arsenide LED					
Forward Voltage		1.3	1.5	V	$I_F = 60 \text{ mA}$
Reverse Current		0.1	10	μA	$V_R = 3.0 \text{ V}$
Capacitance		100		pF	$V_R = 0$
Phototransistor Detector					
BV_{CEO}	30	50		V	$I_C = 1 \text{ mA}$
I_{CEO}		5.0	50	nA	$V_{CE} = 10 \text{ V}, I_F = 0$
Collector-Emitter Capacitance		2.0		pF	$V_{CE} = 0$
BV_{ECO}	7	10		V	$I_E = 100 \mu\text{A}$
Coupled Characteristics					
DC Current Transfer Ratio	0.2	0.35			$I_F = 10 \text{ mA}, V_{CE} = 10 \text{ V}$
V_{SAT}		0.25	0.5	V	$I_C = 1.6 \text{ mA}, I_F = 16 \text{ mA}$
Capacitance, Input to Output		0.5		pF	
Breakdown Voltage	2500			V	D.C.
Resistance, Input to Output		100		$\text{G}\Omega$	
Propagation Delay					
$t_{D ON}$		6.0		μs	$R_L = 2.4\text{K}\Omega, V_{CE} = 5 \text{ V}$
$t_{D OFF}$		25		μs	$I_F = 16 \text{ mA}$

TYPICAL OPTOELECTRONIC CHARACTERISTIC CURVES FOR EACH CHANNEL

FIGURE 1. RELATIVE OUTPUT VS TEMPERATURE

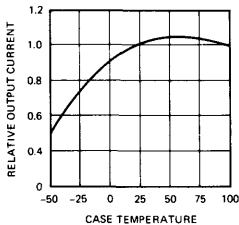

FIGURE 2. DARK CURRENT VS TEMPERATURE

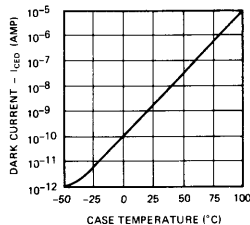

FIGURE 3. TRANSFER CHARACTERISTICS

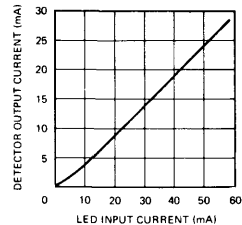

FIGURE 4. DETECTOR OUTPUT CHARACTERISTICS

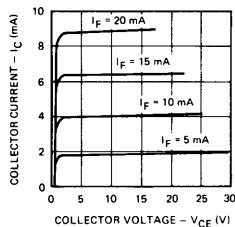
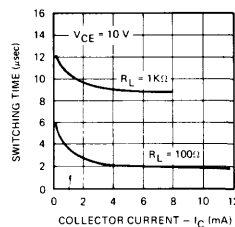

FIGURE 5. SWITCHING TIME VS COLLECTOR CURRENT



PIN CONFIGURATIONS

IL-1

(TOP VIEW)

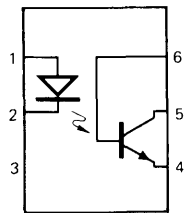

LED CHIP ON PIN 2
PT CHIP ON PIN 5

PIN NO.	FUNCTION
1	ANODE
2	CATHODE
3	NC
4	EMITTER
5	COLLECTOR
6	BASE

ILD-1

(TOP VIEW)

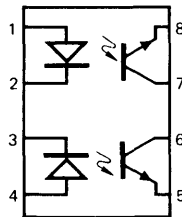

LED CHIPS ON PINS 2 AND 3
PT CHIPS ON PINS 6 AND 7

PIN NO.	FUNCTION
1	ANODE
2	CATHODE
3	CATHODE
4	ANODE
5	EMITTER
6	COLLECTOR
7	COLLECTOR
8	EMITTER

ILQ-1

(TOP VIEW)

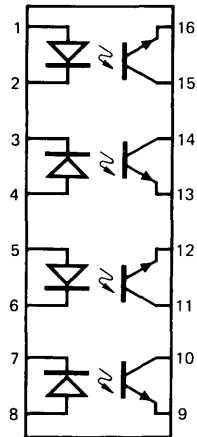

LED CHIPS ON PINS 2, 3, 6, 7
PT CHIPS ON PINS 10, 11, 14, 15

PIN NO.	FUNCTION
1	ANODE
2	CATHODE
3	CATHODE
4	ANODE
5	ANODE
6	CATHODE
7	CATHODE
8	ANODE
9	EMITTER
10	COLLECTOR
11	COLLECTOR
12	EMITTER
13	EMITTER
14	COLLECTOR
15	COLLECTOR
16	EMITTER

**PHOTOTRANSISTOR
OPTO-ISOLATOR**

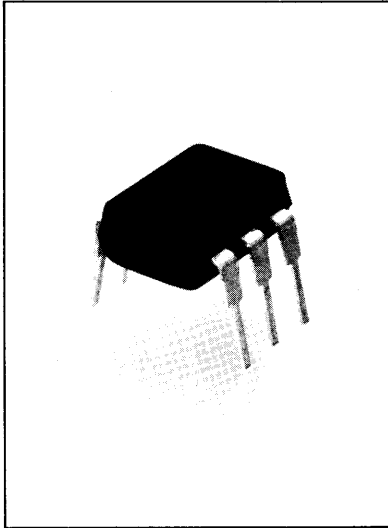

FEATURES

- 2500 Volt Breakdown Voltage
- 70% Typical Transfer Ratio
- Industry Standard Dual-In-Line
- 0.5 pF Coupling Capacitance
- Underwriters Lab Approval #E52744

DESCRIPTION

IL-5 is an optically coupled pair employing a Gallium Arsenide infrared LED and a silicon NPN phototransistor. Signal information, including a DC level, can be transmitted by the device while maintaining a high degree of electrical isolation between input and output. The IL-5 can be used to replace relays and transformers in many digital interface applications, as well as analog applications such as CRT modulation.

Package Dimensions in Inches (mm)

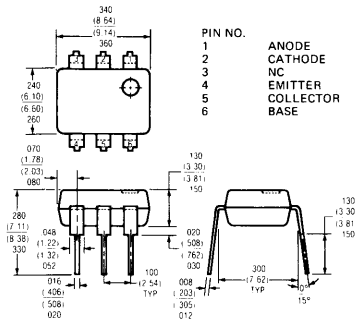

- PIN NO.
- 1 ANODE
 - 2 CATHODE
 - 3 NC
 - 4 EMITTER
 - 5 COLLECTOR
 - 6 BASE

Maximum Ratings

- Gallium Arsenide LED**
- Power Dissipation @ 25°C 200 mW
 - Derate Linearly from 25°C 2.6 mW/°C
 - Continuous Forward Current 100 mA
 - Peak Inverse Voltage 3.0 V
- Detector (Silicon Phototransistor)**
- Power Dissipation @ 25°C 200 mW
 - Derate Linearly From 25°C 2.6 mW/°C
 - Collector-Emitter Breakdown Voltage (BV_{CEO}) 30 V
 - Emitter-Collector Breakdown Voltage (BV_{ECO}) 7 V
 - Collector-Base Breakdown Voltage (BV_{CBO}) 70 V

Package

- Total Package Dissipation at 25°C Ambient (LED Plus Detector) 250 mW
- Derate Linearly From 25°C 3.3 mW/°C
- Storage Temperature -55 to +150°C
- Operating Temperature -55 to +100°C
- Lead Soldering Time @ 260°C 10 sec

Electrical Characteristics (at 25°C Ambient)

Parameter	Min	Typ	Max	Unit	Test Condition
Gallium Arsenide LED					
Forward Voltage	1.3	1.5		V	I _F = 60 mA
Reverse Current1	10	μA	V _R = 3.0 V
Capacitance	100			pF	V _R = 0
Phototransistor Detector					
HFE	450				V _{CE} = 5.0 V I _C = 100 μA
BV _{CEO}	30	50		V	I _C = 1 mA
BV _{ECO}	7	10		V	I _E = 100 μA
I _{CEO} (dark)		5	50	nA	V _{CE} = 10 V I _F = 0
Collector-Emitter Capacitance	2			pF	V _{CE} = 0
Coupled Characteristics					
DC Current Transfer	0.5	0.70			I _F = 10 mA, V _{CE} = 10V
Collector-Emitter Saturation Voltage V _{CE(sat)}	0.25	0.5V			I _F = 16 mA I _C = 1.6 mA
Capacitance, Input to Output5		pF	
Breakdown Voltage	2,500			V	D.C.
Resistance, Input to Output		100		GΩ	
Output Rise and Fall Times		2		μs	I _F = 10 mA V _{CE} = 10 V

Specifications subject to change without notice.

TYPICAL OPTO-ELECTRONIC CHARACTERISTIC CURVES

FIGURE 1. RELATIVE OUTPUT VS TEMPERATURE

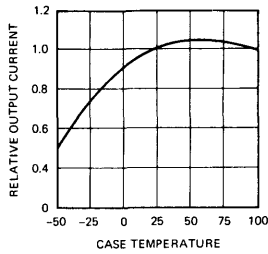

FIGURE 2. DARK CURRENT VS TEMPERATURE

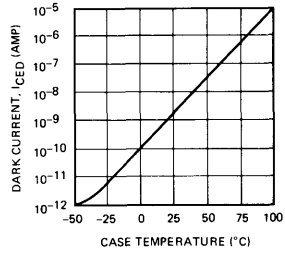

FIGURE 3. TRANSFER CHARACTERISTICS

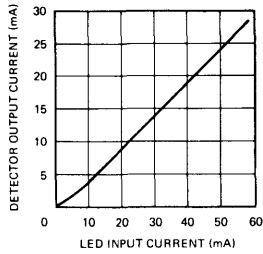

FIGURE 4. DETECTOR OUTPUT CHARACTERISTICS

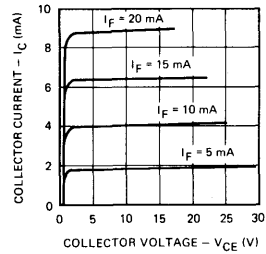
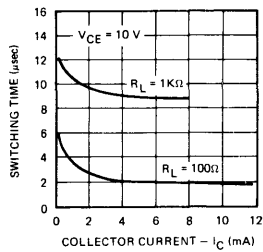
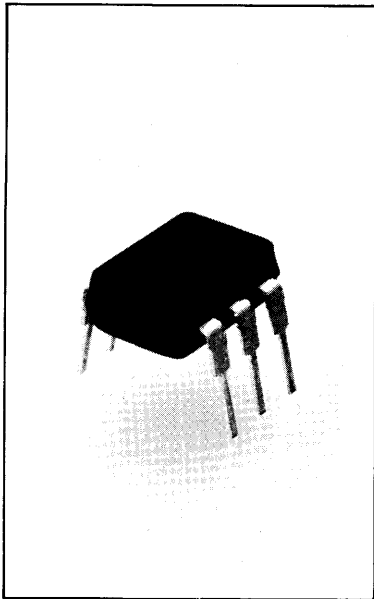

FIGURE 5. SWITCHING TIME VS COLLECTOR CURRENT



**PHOTOTRANSISTOR
OPTO-ISOLATOR**



FEATURES

- 1000 Volt Breakdown Voltage
- 10% Minimum Current Transfer Ratio
- 2 pF max. Coupling Capacitance
- Standard Dual-In-Line Package
- Replacement For TIL-112
- Underwriters Lab Approval #E52744

DESCRIPTION

IL-12 is an optically coupled pair employing a Gallium Arsenide infrared LED and a silicon NPN phototransistor. Signal information, including a DC level, can be transmitted by the device while maintaining a high degree of electrical isolation between input and output. The IL-12 can be used to replace relays and transformers in many digital interface applications, as well as analog applications such as CRT modulation.

Package Dimensions in Inches (mm)

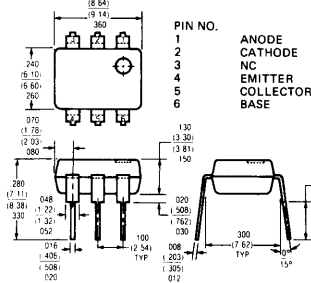

Maximum Ratings

Gallium Arsenide LED	
Power Dissipation @ 25°C	200 mW
Derate Linearly from 25°C	2.6 mW/°C
Continuous Forward Current	100 mA
Peak Inverse Voltage	3.0V
Detector (Silicon Phototransistor)	
Power Dissipation at 25°C	200 mW
Derate Linearly from 25°C	2.6 mW/°C
Collector-Emitter Breakdown Voltage (BVCEO)	30V
Emitter-Collector Breakdown Voltage (BVECO)	7V
Collector-Base Breakdown Voltage (BV CBO)	70 V
Package	
Total Package Dissipation at 25°C Ambient (LED Plus Detector)	250 mW
Derate Linearly From 25°C	3.3 mW/°C
Storage Temperature	-55°C to +150°C
Operating Temperature	-55°C to +100°C
Lead Soldering Time @ 260°C	10 sec

Electrical Characteristics (at 25°C Ambient)

Parameter	Min	Typ	Max	Unit	Test Condition
Gallium Arsenide LED					
Forward Voltage			1.5	V	I _F = 10 mA
Reverse Current			100	μA	V _R = 3.0V
Capacitance		100		pF	V _R = 0
Phototransistor Detector					
H _{FE}		50			V _{CE} = 5.0V
BV _{CEO}	20	60		V	I _C = 100 μA
BV _{ECO}	4	10		V	I _E = 100 μA
I _{CEO} (dark)		5	250	nA	V _{CE} = 5V
Collector-Emitter					
Capacitance		2		pF	V _{CE} = 0
Output Rise and Fall Times					
Output Rise and Fall Times		2		μs	I _F = 10 mA V _{CE} = 10V
Coupled Characteristics					
DC Current Transfer Ratio					
DC Current Transfer Ratio	.10	.20			I _F = 10 mA V _{CE} = 5V R _L = 100 Ω
V_{CE} (SAT)					
V _{CE} (SAT)		0.3	0.5	V _I	I _C = 2 mA I _F = 50 mA
Capacitance, Input to Output					
Capacitance, Input to Output			2	pF	
Breakdown Voltage					
Breakdown Voltage	1000			V	D.C.
Resistance, Input to Output					
Resistance, Input to Output		100		GΩ	

Specifications subject to change without notice.

TYPICAL OPTO-ELECTRONIC CHARACTERISTIC CURVES

FIGURE 1. RELATIVE OUTPUT VS TEMPERATURE

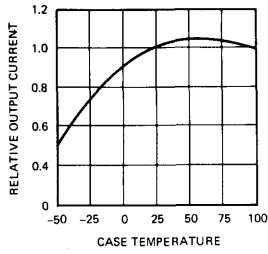

FIGURE 2. DARK CURRENT VS TEMPERATURE

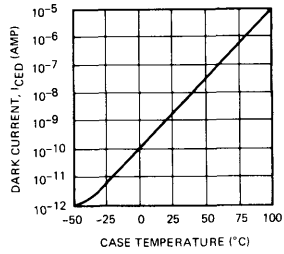

FIGURE 3. TRANSFER CHARACTERISTICS

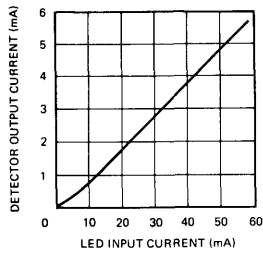

FIGURE 4. DETECTOR OUTPUT CHARACTERISTICS

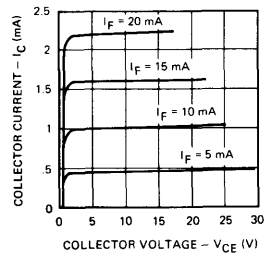
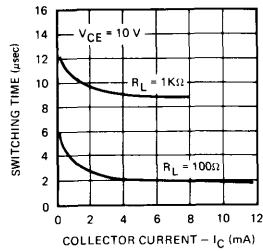
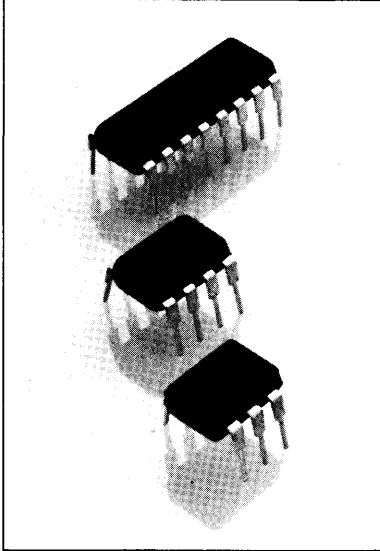

FIGURE 5. SWITCHING TIME VS COLLECTOR CURRENT



IL-74 SINGLE CHANNEL ILD-74 DUAL CHANNEL ILQ-74 QUAD CHANNEL

PHOTOTRANSISTOR
OPTO-ISOLATOR



FEATURES

- 7400 series T²L compatible
- 1500 volt breakdown voltage
- 35% typical transfer ratio
- 0.5 pF coupling capacitance
- Industry standard dual-in-line package
- Single channel, dual, and quad configurations
- Underwriters Lab Approval #E52744

DESCRIPTION

IL-74 is an optically coupled pair employing a Gallium Arsenide infrared LED and a silicon NPN phototransistor. Signal information, including a DC level, can be transmitted by the device while maintaining a high degree of electrical isolation between input and output. The IL-74 is especially designed for driving medium-speed logic, where it may be used to eliminate troublesome ground loop and noise problems. It can also be used to replace relays and transformers in many digital interface applications, as well as analog applications such as CRT modulation. The ILD-74 offers two isolated channels in a single DIP package while the ILQ-74 provides four isolated channels per package.

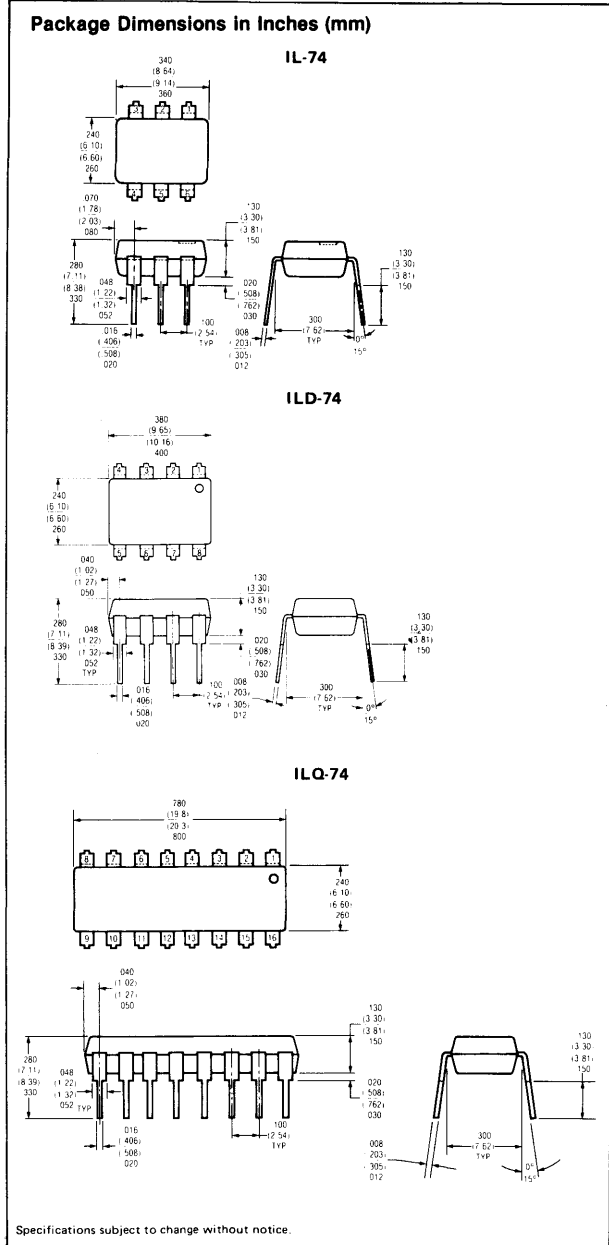

MAXIMUM RATINGS

Gallium Arsenide LED (each channel)

Power Dissipation @ 25°C	150 mW
Derate Linearly from 25°C	1.33 mW/°C
Continuous Forward Current	100 mA
Peak Inverse Voltage	3.0V

Detector-Silicon Phototransistor (each channel)

Power Dissipation @ 25°C	150 mW
Derate Linearly from 25°C	2.0 mW/°C
Collector-Emitter Breakdown Voltage (BV _{CEO})	20V

Package

Total Package Dissipation at 25°C Ambient (LED Plus Detector)

IL-74	200 mW
ILD-74	400 mW
ILQ-74	500 mW

Derate Linearly From 25°C

IL-74	3.3 mW/°C
ILD-74	5.33 mW/°C
ILQ-74	6.67 mW/°C

Storage Temperature	-55°C to +150°C
Operating Temperature	-55°C to +100°C
Lead Soldering Time @ 260°C	10 sec

ELECTRICAL CHARACTERISTICS PER CHANNEL (at 25°C Ambient)

Parameter	Min	Typ	Max	Units	Test Conditions
Gallium Arsenide LED					
Forward Voltage		1.3		V	I _F = 100 mA
Reverse Current		0.1		μA	V _R = 3.0V
Capacitance		100		pF	V _R = 0
Phototransistor Detector					
BV _{CEO}	20	50		V	I _C = 1 mA
I _{CEO}		5.0	500	nA	V _{CE} = 5V, I _F = 0
Collector-Emitter Capacitance		2.0		pF	V _{CE} = 0
Coupled Characteristics					
DC Current Transfer Ratio	0.125	0.35			I _F = 16 mA, V _{CE} = 5V
V _{SAT}		0.3	0.5	V	I _C = 2 mA, I _F = 16 mA
Capacitance, Input to Output		0.5		pF	
Breakdown Voltage	1500			VDC	
Resistance, Input to Output		100		GΩ	
Propagation Delay					
t _{D ON}		6.0		μs	R _L = 2.4KΩ, V _{CE} = 5V
t _{D OFF}		25		μs	I _F = 16 mA

Specifications subject to change without notice.

TYPICAL OPTOELECTRONIC CHARACTERISTIC CURVES FOR EACH CHANNEL

FIGURE 1. RELATIVE OUTPUT VS TEMPERATURE

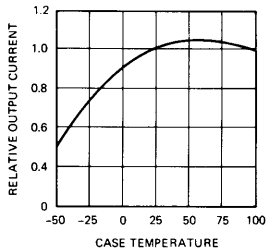

FIGURE 2. DARK CURRENT VS TEMPERATURE

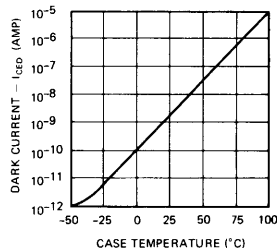

FIGURE 3. TRANSFER CHARACTERISTICS

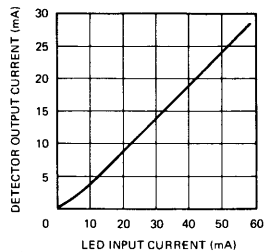

FIGURE 4. DETECTOR OUTPUT CHARACTERISTICS

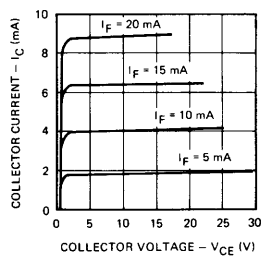
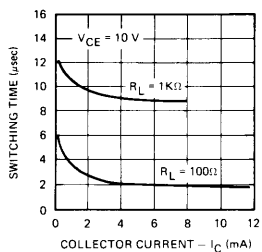

FIGURE 5. SWITCHING TIME VS COLLECTOR CURRENT



PIN CONFIGURATIONS

IL-74

(TOP VIEW)

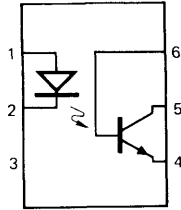

LED CHIP ON PIN 2
PT CHIP ON PIN 5

PIN NO.	FUNCTION
1	ANODE
2	CATHODE
3	NC
4	EMITTER
5	COLLECTOR
6	BASE

ILD-74

(TOP VIEW)

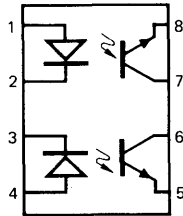

LED CHIPS ON PINS 2 AND 3
PT CHIPS ON PINS 6 AND 7

PIN NO.	FUNCTION
1	ANODE
2	CATHODE
3	CATHODE
4	ANODE
5	EMITTER
6	COLLECTOR
7	COLLECTOR
8	EMITTER

ILQ-74

(TOP VIEW)

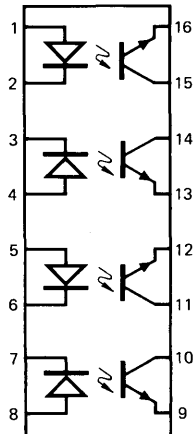

LED CHIPS ON PINS 2, 3, 6, 7
PT CHIPS ON PINS 10, 11, 14, 15

PIN NO.	FUNCTION
1	ANODE
2	CATHODE
3	CATHODE
4	ANODE
5	ANODE
6	CATHODE
7	CATHODE
8	ANODE
9	EMITTER
10	COLLECTOR
11	COLLECTOR
12	EMITTER
13	EMITTER
14	COLLECTOR
15	COLLECTOR
16	EMITTER

PHOTOTRANSISTOR OPTO-ISOLATOR

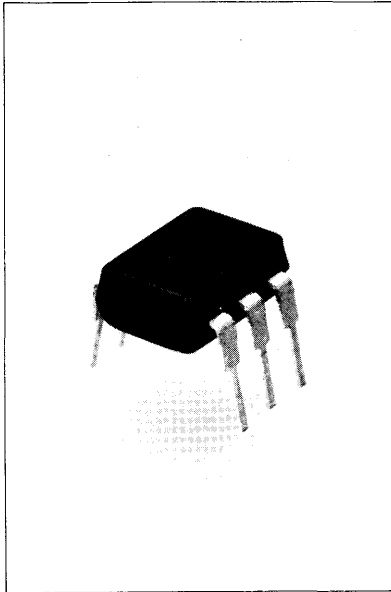

FEATURES

- 5000 Volt Breakdown Voltage
- High Current-Transfer-Ratio (75%–450%)
- Long Term Stability
- Industry Standard Dual-In-Line
- 1 mA Current-Transfer-Ratio Guarantee
- Underwriters Lab Approval #E52744

DESCRIPTION

IL-201, IL-202, IL-203 are optically coupled pairs employing a Gallium Arsenide infrared LED and a silicon NPN phototransistor. Signal information, including a DC level, can be transmitted by the device while maintaining a high degree of electrical isolation between input and output. The IL-201, IL-202, IL-203 can be used to replace relays and transformers in many digital interface applications, as well as analog applications such as CRT modulation.

Package Dimensions in Inches (mm)

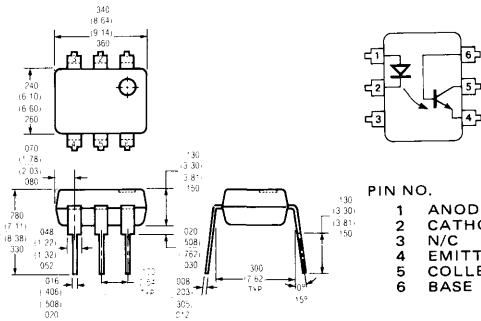

- PIN NO.
- 1 ANODE
 - 2 CATHODE
 - 3 N/C
 - 4 EMITTER
 - 5 COLLECTOR
 - 6 BASE

Maximum Ratings

Gallium Arsenide LED	
Power Dissipation @ 25°C	.200 mW
Derate Linearly from 25°C	2.6 mW/°C
Continuous Forward Current	100 mA
Peak Inverse Voltage	6.0 V
Detector (Silicon Phototransistor)	
Power Dissipation @ 25°C	.200 mW
Derate Linearly From 25°C	2.6 mW/°C
Collector-Emitter Breakdown Voltage (BV _{CEO})	30 V
Emitter-Collector Breakdown Voltage (BV _{EBO})	7 V
Collector-Base Breakdown Voltage (BV _{CBO})	70 V
Package	
Total Package Dissipation at 25°C Ambient (LED Plus Detector)	.250 mW
Derate Linearly From 25°C	3.3 mW/°C
Storage Temperature	-55 to +150°C
Operating Temperature	-55 to +100°C
Lead Soldering Time @ 260°C	10 sec

Electrical Characteristics (0°C – 70°C unless otherwise specified)

Parameter	Min	Typ	Max	Unit	Test Condition
Gallium Arsenide LED					
Forward Voltage V _F		1.2	1.5	V	I _F = 20 mA
Forward Voltage V _F		1.0	1.2	V	I _F = 1 mA
Reverse Current I _R		0.01	10	µA	V _R = 6 V T _A = 25°C
Breakdown Voltage V _R	6	20		V	I _R = 10 µA
Phototransistor Detector					
H _{FE}	100	200			V _{CE} = 5V, I _C = 100 µA
BV _{CEO}	30	50		V	I _C = 1 mA
BV _{EBO}	7	10		V	I _C = 100 µA
BV _{CBO}	70	90		V	I _C = 100 µA
I _{CBO}		5	50	NA	V _{CE} = 10 V, T _A = 25°C
Coupled Characteristics					
Base Current					
Transfer Ratio (BTR)	0.15			%	I _F = 10 mA V _{CE} = 10 V
V _{CE (sat)}			0.4	V	I _F = 10 mA I _C = 2 mA
DC Current Transfer Ratio (CTR)					
IL-201	75	100	150	%	I _F = 10 mA V _{CE} = 10 V
IL-202	125	200	250	%	
IL-203	225	300	450	%	
DC Current Transfer Ratio (CTR)					
IL-201	10			%	I _F = 1 mA
IL-202	30			%	V _{CE} = 10 V
IL-203	50			%	
Input to Output					
Isolation Voltage	5000			V	D.C.

Specifications subject to change without notice.

4N25, 4N26, 4N27, 4N28

PHOTOTRANSISTOR OPTO-ISOLATORS

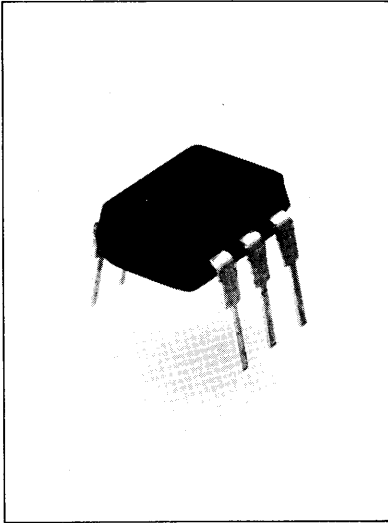

FEATURES

- 2500 Volt Breakdown Voltage
- High DC Current Transfer Ratio
- I/O Compatible with Integrated Circuits
- 0.5pF Coupling Capacitance
- Underwriter Lab Approval #E52744

DESCRIPTION

The LITRONIX 4N25, 4N26, 4N27, and 4N28 series are optically coupled pairs, each consisting of a Gallium Arsenide infrared LED and a silicon NPN phototransistor. Signal information, including a DC level, can be transmitted by the device while maintaining a high degree of electrical isolation between input and output. They can be used to replace relays and transformers in many digital interface applications. They have excellent frequency response when used in analog applications.

Package Dimensions in Inches (mm)

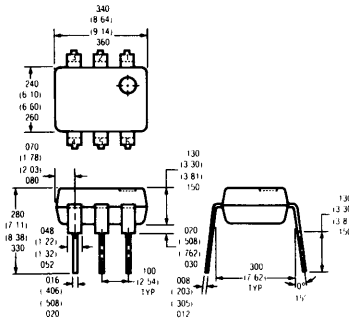

CONNECTION DIAGRAM DIP (TOP VIEW)

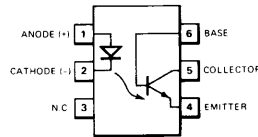

PIN NUMBERS

- | | | |
|---|-------------|------------------------------|
| 1 | Anode (+) | } Input Diode |
| 2 | Cathode (-) | |
| 3 | NC | } Output npn Phototransistor |
| 4 | Emitter | |
| 5 | Collector | |
| 6 | Base | |

Absolute Maximum Ratings:

Gallium Arsenide LED:

- * Power Dissipation @ 25°C 150mW
- * Derate Linearly from 25°C 2.0 mW/°C
- * Continuous Forward Current 80mA
- * Forward Current Peak (1μs pulse, 300 pps) 3.0 A
- * Peak Inverse Voltage 3.0V

Detector (Silicon Photo-Transistor)

- * Power Dissipation @ 25°C 150mW
- * Derate Linearly from 25°C 2.0mW/°C
- * Collector-Emitter Breakdown Voltage (BV_{CEO}) 30V
- * Emitter-Collector Breakdown Voltage (BV_{CBO}) 7.0 V
- * Collector-Base Breakdown Voltage 70V

Package

- * Total Package Dissipation @ 25°C Ambient (equal power in each element) 250mW
- * Derate Linearly from 25°C 3.3mW/°C
- * Storage Temperature -55°C to +150°C
- * Operating Temperature -55°C to +100°C
- * Lead Soldering Time @ 260°C 10 sec.

* indicates JEDEC registered values

Specifications subject to change without notice.

ELECTRICAL CHARACTERISTICS

PARAMETERS (at 25° Ambient)

Parameter	Min	Typ	Max	Unit	Test Condition
Gallium Arsenide LED					
* Forward Voltage		1.3	1.5	V	$I_F=50\text{mA}$
* Reverse Current		0.1	100	μA	$V_R=3.0\text{V}$
Capacitance		100		pF	$V_R=0$
Photo-transistor Detector					
H_{FE}		150			$V_{CE}=5.0\text{V}$
* BV_{CEO}	30			V	$I_C=1\text{mA}$
* BV_{ECO}	7			V	$I_E=100\mu\text{A}$
* BV_{CBO}	70			V	$I_C=100\mu\text{A}$
* I_{CEO} (dark) 4N25,				nA	$V_{CE}=10\text{V}$
4N26, 4N27		5	50	nA	(base open)
4N28		10	100	nA	$V_{CB}=10\text{V}$
* I_{CBO} ($I_F=0$)		2	20	nA	(emitter open)
Collector-Emitter Capacitance		2		pF	$V_{CE}=0$
Coupled Characteristics					
* DC Current Transfer Ratio					
4N25,					$I_F=10\text{mA}$
4N26	0.2	0.5			$V_{CE}=10\text{V}$
4N27, 4N28	0.1	0.3			$I_F=10\text{mA}$
Capacitance, Input to Output		0.5		pF	$V_{CE}=10\text{V}$
* Breakdown Voltage 4N25	2500			V	Peak
4N26, 4N27	1500			V	Peak
4N28	500			V	Peak
* Resistance, Input to Output	100			$G\Omega$	
Rise and Fall Times		2		μs	$I_F=10\text{mA}$
* Collector-Emitter Saturation Voltage			0.5	V	$I_F=50\text{mA}$
					$I_C=2.0\text{mA}$

* indicates JEDEC registered values

TYPICAL CURVES

FIGURE 1. RELATIVE OUTPUT VS TEMPERATURE

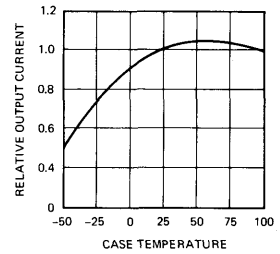

FIGURE 2. DARK CURRENT VS TEMPERATURE

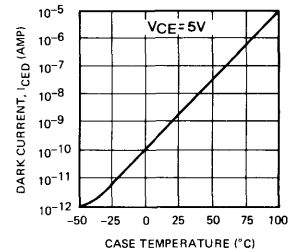

FIGURE 3. TRANSFER CHARACTERISTICS

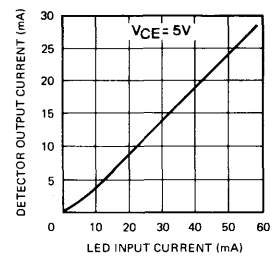
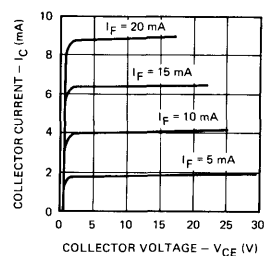
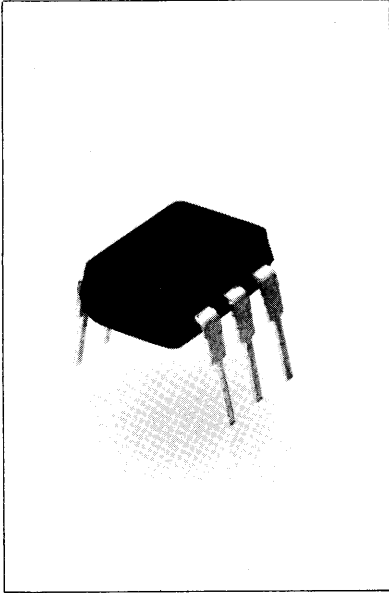

FIGURE 4. DETECTOR OUTPUT CHARACTERISTICS



4N35, 4N36, 4N37

PHOTOTRANSISTOR OPTO-ISOLATOR



FEATURES

- 1500 to 3500 Volt Breakdown Voltage
- High Current-Transfer-Ratio (100% Min)
- Industry Standard Dual-In-Line
- 0.5 pF Coupling Capacitance
- Underwriters Lab Approval #E52744

DESCRIPTION

4N35, 4N36, 4N37 are optically coupled pairs employing a Gallium Arsenide infrared LED and a silicon NPN phototransistor. Signal information, including a DC level, can be transmitted by the device while maintaining a high degree of electrical isolation between input and output. The 4N35, 4N36, 4N37 can be used to replace relays and transformers in many digital interface applications, as well as analog applications such as CRT modulation.

Package Dimensions in Inches (mm)

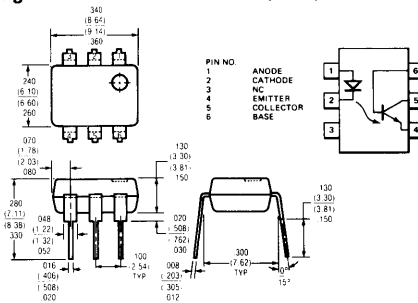

Maximum Ratings

Gallium Arsenide LED	
Power Dissipation @ 25°C	100 mW
Derate Linearly from 25°C	1.33 mW/°C
Continuous Forward Current	60 mA
Peak Inverse Voltage	6.0 V
Detector (Silicon Phototransistor)	
Power Dissipation @ 25°C	300 mW
Derate Linearly from 25°C	4.0 mW/°C
Collector-Emitter Breakdown Voltage (BV _{CEO})	30 V
Emitter-Collector Breakdown Voltage (BV _{ECO})	7 V
Collector-Base Breakdown Voltage (BV _{CBO})	70 V
Package	
Storage Temperature*	-55 to +150°C
Operating Temperature	-55 to +100°C
Lead Soldering Time @ 260°C	10 sec
Relative Humidity @ 85°C*	85%

Electrical Characteristics (at 25°C Ambient)

Parameter	Min	Typ	Max	Unit	Test Condition
Gallium Arsenide LED					
Forward Voltage*		1.3	1.5	V	I _F = 10 mA
Reverse Current*		.1	10	µA	V _R = 6.0 V
Capacitance			100	pF	V _R = 0 f = 1 MHz
Phototransistor Detector					
H _{FE}	100	150			V _{CE} = 5.0 V I _C = 100 µA
BV _{CEO} *	30			V	I _E = 1 mA
BV _{CEO}	7			V	I _E = 100 µA
I _{CEO} (dark)		5	50	nA	V _{CE} = 10 V, I _F = 0
I _{CEO} (dark)*			500	µA	V _{CE} = 30 V, I _F = 0 T _A = 100°C
BV _{CBO} *	70			V	I _C = 100 µA
Collector-Emitter Capacitance		2		pF	V _{CE} = 0
Coupled Characteristics					
DC Current Transfer					
Ratio*	100			%	I _F = 10 mA, T _A = 25°C V _{CE} = 10 V
DC Current Transfer					
Ratio*	40			%	I _F = 10 mA V _{CE} = 10 V T _A = 55° to 100°C
Capacitance, Input					
to Output*		2.5		pF	f = 1.0 MHz
Resistance, Input					
to Output*		10 ¹¹		Ω	V _{IO} = 500 V I _C = 2 mA
T _{on} T _{off}		10		µs	R _L = 100 Ω V _{CC} = 10 V
Collector-Emitter Saturation					
Voltage V _{CE(sat)} *		0.3		V	I _F = 10 mA I _C = 0.5 mA
Input to Output Isolation					
Current (Pulse Width = 8 m. sec)*				µA	V _{IO} = 3550 V
4N35			100	µA	V _{IO} = 2500 V
4N36			100	µA	V _{IO} = 1500 V
4N37			100	µA	V _{IO} = 1500 V

* Indicates JEDEC Registered Data
Specifications subject to change without notice.

**PHOTO DARLINGTON
OPTO-ISOLATOR**

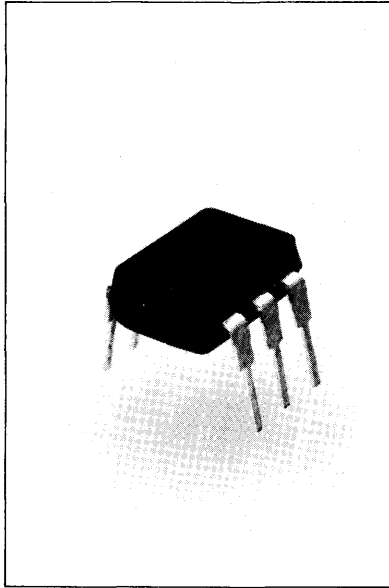

FEATURES

- 1500 or 2500 Volt Isolation Voltage
- 500% CTR
- High Isolation Resistance ($10^{11} \Omega$ Typical)
- Low Coupling Capacitance
- Standard Plastic Dip Package
- Underwriters Lab Approval #E52744

DESCRIPTION

The 4N32 and 4N33 are optically coupled isolators employing a gallium arsenide infrared emitter and a silicon photo darlington sensor. Switching can be accomplished while maintaining a high degrees of isolation between driving and load circuits. They can be used to replace reed and mercury relays with advantages of long life, high speed switching and elimination of magnetic fields.

Package Dimensions in Inches (mm)

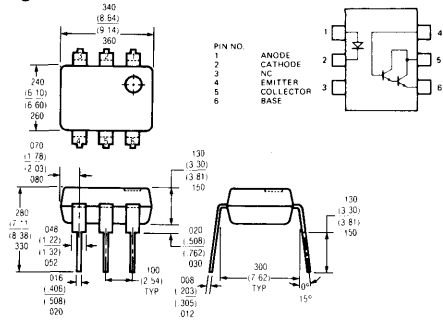

Maximum Ratings

Gallium Arsenide LED (Drive Circuit)	
Power Dissipation at 25°C	150 mW
Derate Linearly From 25°C	2 mW/°C
Continuous Forward Current	80 mA
Peak Reverse Voltage	3 V
Photodarlington Sensor (Load Circuit)	
Power Dissipation at 25°C Ambient	150 mW
Derate Linearly From 25°C	2.0 mW/°C
Collector (load) Current	125 mA
Collector-Emitter Breakdown	
Voltage (BV _{CEO})	30 V
Collector-Base Breakdown	
Voltage (BV _{CBO})	50 V
Emitter-Base Breakdown	
Voltage (BV _{EBO})	8 V
Emitter-Collector Breakdown	
Voltage (BV _{Eco})	5 V
Package	
Total Dissipation at 25°C	250 mW
Derate Linearly From 25°C	3.3 mW/°C
Storage Temperature*	-55°C to +150°C
Operating Temperature	-55°C to +100°C
Lead Soldering Time at 260°C	10 sec

Electrical Characteristics (at 25°C Ambient)

Parameter	Min	Typ	Max	Unit	Test Condition
GaAs Emitter					
Forward Voltage*		1.25	1.5	V	I _F = 50 mA
Reverse Current*		0.01	100	μA	V _R = 3.0 V
Capacitance			100	pF	V _R = 0
Sensor					
H _{FE}			13K		V _{CE} = 5 V I _C = 0.5 mA I _E = 100 μA
BV _{CEO} *	30			V	I _F = 0
BV _{CBO} *	50			V	I _C = 100 μA I _F = 0
BV _{EBO} *	8			V	I _C = 100 μA I _F = 0
BV _{Eco} *	5			V	I _E = 100 μA V _{CE} = 10 V
I _{CEO} *		1.0	100	nA	V _{CE} = 10 V I _F = 0
Coupled Characteristics					
Current Transfer Ratio*	500			%	I _F = 10 mA V _{CE} = 10 V I _C = 2 mA
V _{CE(SAT)}			1.0	V	I _F = 8 mA V _{IO} = 500 V
Isolation Resistance*		10 ¹¹		ohm	
Isolation Capacitance		1.5		pf	
Turn-on Time			5	μs	V _{CC} = 10 V I _C = 50 mA
Turn-off Time			120	μs	I _F = 200 mA R _L = 180 Ω
Input to Output Current*					Pulse Width = 8ms
4N32			100	μA	V _{IO} = 2500 V
4N33			100	μA	V _{IO} = 1500 V

*Indicates JEDEC Registered Data

Specifications subject to change without notice.

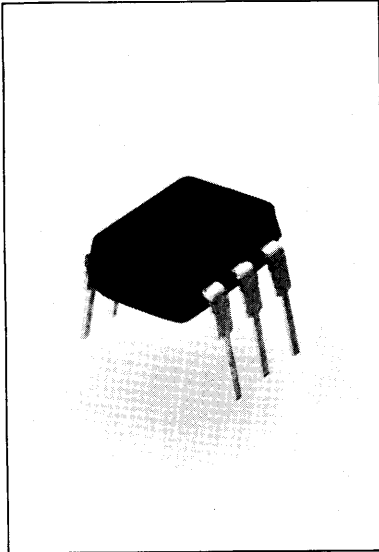

FEATURES

- 1500 Volt Isolation Voltage
- 100 mA Load Current Rating
- Fast Turn On Time – 10 μ s
- Fast Turn Off Time – 35 μ s
- Solid State Reliability
- Standard Plastic DIP Package
- Underwriter Lab Approval #E52744

DESCRIPTION

The ILA-30 and ILA-55 are optically coupled isolators employing a gallium arsenide infrared emitter and a silicon photo darlington sensor. Switching can be accomplished while maintaining a high degree of isolation between driving and load circuits. They can be used to replace reed and mercury relays with advantages of long life, high speed switching and elimination of magnetic fields.

Package Dimensions in Inches (mm)

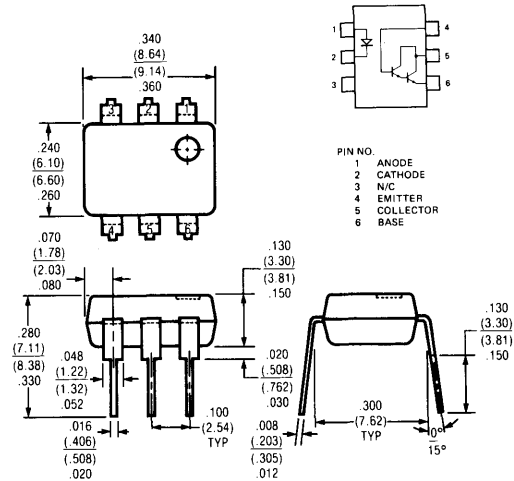

Maximum Ratings

Gallium Arsenide LED (Drive Circuit)		
Power Dissipation at 25°C	90 mW	
Derate Linearly From 55°C	1.2 mW/°C	
Continuous Forward Current	60 mA	
Peak Reverse Voltage	3V	
Photodarlington Sensor (Load Circuit)	ILA-30	ILA-55
Power Dissipation at 25°C Ambient	210 mW	210 mW
Derate Linearly From 25°C	2.8 mW/°C	2.8 mW/°C
Collector (load) Current	100 mA	100 mA
Collector-Emitter Breakdown		
Voltage (BV _{CEO})	30V	55V
Collector-Base Breakdown		
Voltage (BV _{CBO})	30V	55V
Emitter-Base Breakdown		
Voltage (BV _{EBO})	8V	8V
Package		
Total Dissipation at 25°C	250 mW	
Derate Linearly From 25°C	3.3 mW/°C	
Storage Temperature	-55°C to +150°C	
Operating Temperature	-55°C to +100°C	
Lead Soldering Time at 260°C	10 sec	

Specifications subject to change without notice.

Opto-Electrical Characteristics (at 25° Ambient)

Parameter	Min	Typ	Max	Unit	Test Condition
GaAs Emitter					
Forward Voltage	1.25	1.5		V	$I_F = 60\text{mA}$
Reverse Current	0.01	10		μA	$V_R = 3.0\text{V}$
Capacitance	50			pF	$V_R = 0$
Sensor					
H_{FE}		13K			$V_{CE} = 5\text{V}$ $I_C = 0.5\text{mA}$
BV_{CEO}	30/55			V	$I_C = 100\mu\text{A}$ $I_F = 0$
BV_{CBO}	30/55			V	$I_C = 10\mu\text{A}$ $I_F = 0$
BV_{EBO}	8			V	$I_E = 1\mu\text{A}$ $I_F = 0$
I_{CEO}	0.01	1.0		μA	$V_{CE} = 5\text{V}$ $I_F = 0$
Capacitance					
Collector-Emitter	3.4			pF	$V_{CE} = 10\text{V}$
Collector-Base	10			pF	$V_{CB} = 10\text{V}$
Emitter-Base	10			pF	$V_{EB} = 0.5\text{V}$
Coupled Characteristics					
Current Transfer Ratio	100			%	$I_F = 10\text{mA}$ $V_{CE} = 5\text{V}$
$V_{CE(SAT)}$			1.0	V	$I_C = 60\text{mA}$
Rise Time	10			μs	$V_{CE} = 13.5\text{V}$
Fall Time	35			μs	$I_F = 50\text{mA}$ $R_L = 100\Omega$
Isolation Voltage	1500			V	
Isolation Resistance		10^{11}		ohm	
Isolation Capacitance		0.5		pf	

TYPICAL OPTO-ELECTRONIC CHARACTERISTIC CURVES

FIGURE 1. GaAs EMITTER: FORWARD CURRENT – VOLTAGE CHARACTERISTICS

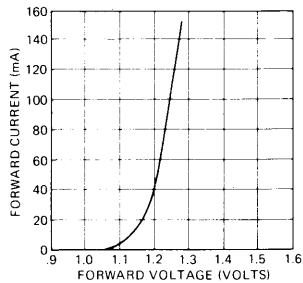

FIGURE 2. DARLINGTON TRANSISTOR OUTPUT CURRENT VS VOLTAGE

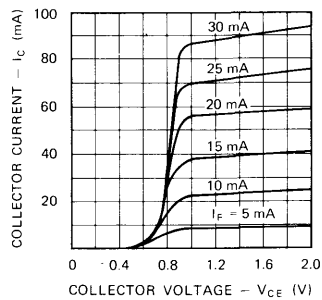

FIGURE 3. DARLINGTON TRANSISTOR CURRENT VS VOLTAGE

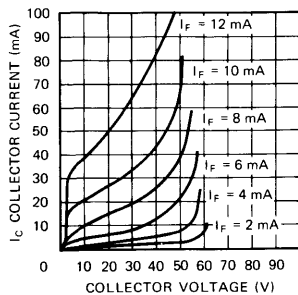
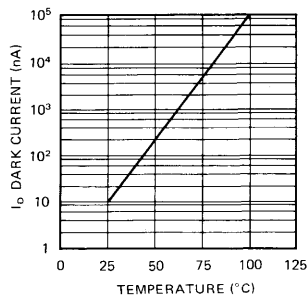
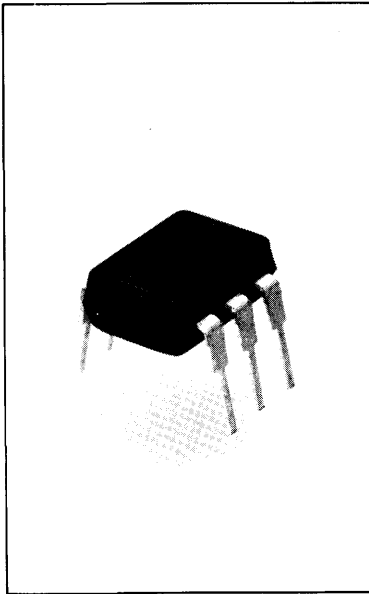

FIGURE 4. DARK CURRENT VS TEMPERATURE



**PHOTO DARLINGTON
OPTO-ISOLATORS**



FEATURES

- 2500 Volt Isolation Voltage
- Equivalent to MCA2-30/MCA2-55
- 125 mA Load Current Rating
- Fast Turn On Time – 10 μ s
- Fast Turn Off Time – 35 μ s
- Solid State Reliability
- Standard Plastic DIP Package
- Underwriter Lab Approval #E52744

DESCRIPTION

The ILCA2-30 and ILCA2-55 are optically coupled isolators employing a gallium arsenide infrared emitter and a silicon photo darlington sensor. Switching can be accomplished while maintaining a high degree of isolation between driving and load circuits. They can be used to replace reed and mercury relays with advantages of long life, high speed switching and elimination of magnetic fields.

Package Dimensions in Inches (mm)

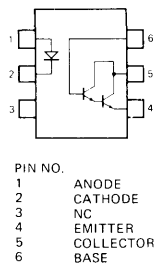
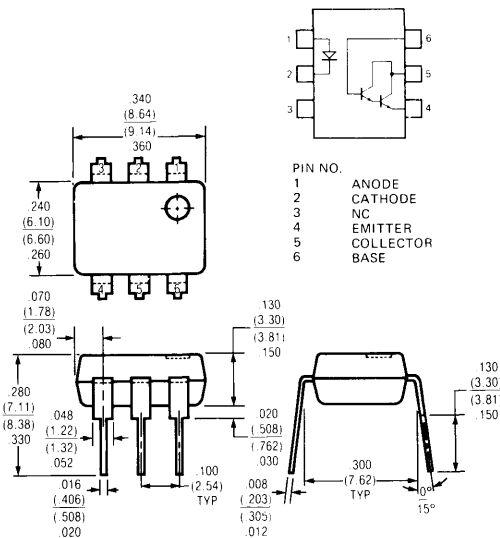

PIN NO.
1 ANODE
2 CATHODE
3 NC
4 EMITTER
5 COLLECTOR
6 BASE

Maximum Ratings

Gallium Arsenide LED (Drive Circuit)			
Power Dissipation at 25°C	90 mW		
Derate Linearly From 55°C	1.2 mW/°C		
Continuous Forward Current	60 mA		
Peak Reverse Voltage	3V		
Photodarlington Sensor (Load Circuit)			
Power Dissipation at 25°C Ambient	ILCA2-30 210 mW	ILCA2-55 210 mW	
Derate Linearly From 25°C	2.8 mW/°C	2.8 mW/°C	2.8 mW/°C
Collector (load) Current	125 mA	125 mA	
Collector-Emitter Breakdown Voltage (BV _{CEO})	30V	55V	
Collector-Base Breakdown Voltage (BV _{CBO})	30V	55V	
Emitter-Base Breakdown Voltage (BV _{EBO})	8V	8V	
Package			
Total Dissipation at 25°C	250 mW		
Derate Linearly From 25°C	3.3 mW/°C		
Storage Temperature	-55°C to +150°C		
Operating Temperature	-55°C to +100°C		
Lead Soldering Time at 260°C	10 sec		

Specifications subject to change without notice.

TYPICAL OPTO-ELECTRONIC CHARACTERISTIC CURVES

Electrical Characteristics (at 25° Ambient)				Test
Parameter	Min	Typ	Max	Unit Condition
GaAs Emitter				
Forward Voltage	1.25	1.5		V $I_F = 20\text{mA}$
Reverse Current	0.01	10		μA $V_R = 3.0\text{V}$
Capacitance	50			pF $V_R = 0$
Sensor				
H_{fe}	13K			$V_{CE} = 5\text{V}$ $I_C = 0.5\text{mA}$
BV_{CEO}	30/55			V $I_C = 100\mu\text{A}$ $I_F = 0$
BV_{CBO}	30/55			V $I_C = 10\mu\text{A}$ $I_F = 0$
BVE_{BO}	8			V $I_E = 1\mu\text{A}$ $I_F = 0$
I_{CEO}	1.0	100		nA $V_{CE} = 10\text{V}$ $I_F = 0$
Capacitance				
Collector-Emitter	3.4			pF $V_{CE} = 10\text{V}$
Collector-Base	10			pF $V_{CB} = 10\text{V}$
Emitter-Base	10			pF $V_{EB} = 0.5\text{V}$
Coupled Characteristics				
Current Transfer Ratio	100	400		% $I_F = 10\text{mA}$ $V_{CE} = 5\text{V}$
$V_{CE(SAT)}$	0.9	1.0		V $I_C = 50\text{mA}$ $I_F = 50\text{mA}$
Rise Time	10			μs $V_{CE} = 13.5\text{V}$ $I_F = 50\text{mA}$
Fall Time	35			μs $I_F = 50\text{mA}$ $R_L = 100\Omega$
Isolation Voltage	2500			V
Isolation Resistance	10^{11}			ohm
Isolation Capacitance	0.5			pf

FIGURE 1. GaAs EMITTER: FORWARD CURRENT – VOLTAGE CHARACTERISTICS

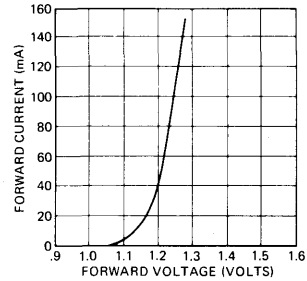

FIGURE 2. DARLINGTON TRANSISTOR OUTPUT CURRENT VS VOLTAGE

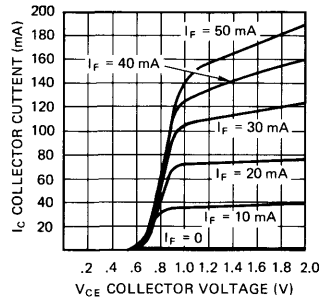

FIGURE 3. DARLINGTON TRANSISTOR CURRENT VS VOLTAGE

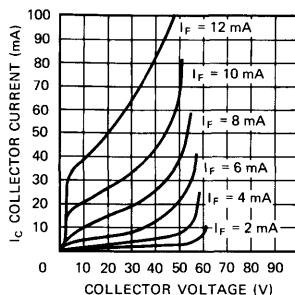
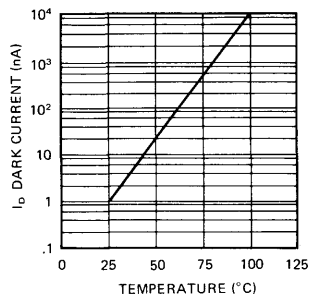
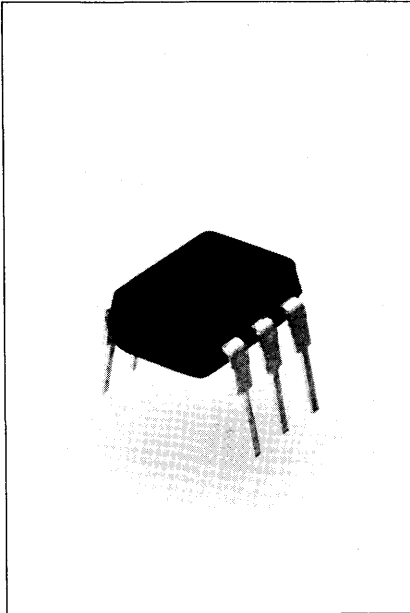

FIGURE 4. DARK CURRENT VS TEMPERATURE





FEATURES

- 1500 Volt Isolation Voltage
- AC or Polarity Insensitive Input
- High Current Transfer Ratio (20% min.)
- Built-in Reverse Polarity Input Protection
- I/O compatible with integrated circuits
- Underwriters Lab Approval #E52744

DESCRIPTION

The H11AA1 is a direct electrical and mechanical replacement of the General Electric series. This bi-directional input optoisolator consists of two gallium arsenide infrared emitting diodes connected in inverse parallel coupled to a silicon NPN phototransistor in a 6 pin dual in-line plastic package.

Package Dimensions in Inches (mm)

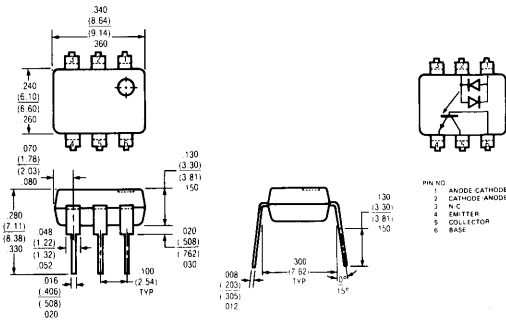

- Pin No
- 1 ANODE CATHODE
 - 2 CATHODE ANODE
 - 3 P. C.
 - 4 EMITTER
 - 5 COLLECTOR
 - 6 BAG

Maximum Ratings

- Gallium Arsenide LED**
- Power Dissipation @ 25°C 100 mW
 - Derate Linearly from 25°C 1.33 mW/°C
 - Continuous Forward Current (RMS) 60 mA
- Detector (Silicon Phototransistor)**
- Power Dissipation @ 25°C 300 mW
 - Derate Linearly From 25°C 4.0 mW/°C
 - Collector-Emitter Breakdown Voltage (BV_{CEO}) 30 V
 - Emitter-Base Breakdown Voltage (BV_{EBO}) 5 V
 - Collector-Base Breakdown Voltage (BV_{CBO}) 70 V

- Package**
- Storage Temperature -55 to +150°C
 - Operating Temperature -55 to +100°C
 - Lead Soldering Time @ 260°C 10.0 sec

Electrical Characteristics (25°C unless otherwise specified)

Parameter	Min	Typ	Max	Unit	Test Condition
Gallium Arsenide LED					
Forward Voltage V _F	—	1.2	1.5	V	I _F = ± 10 mA
Phototransistor Detector					
BV _{CEO}	30	50	—	V	I _C = 10 mA
BV _{EBO}	5	9	—	V	I _E = 100 μA
BV _{CBO}	70	90	—	V	I _C = 100 μA
I _{CEO}	—	5	100	nA	V _{CE} = 10 V
Coupled Characteristics					
V _{CE(set)}	—	0.2	0.4	V	I _F = ± 10 mA I _C = 0.5 mA
DC Current Transfer Ratio					
CTR	20	80	—	%	I _F = ± 10 mA V _{CE} = 10 V
Symmetry					
CTR @ + 10 mA	0.33	1.0	3.0	—	
CTR @ - 10 mA					
Input to Output					
Isolation Voltage	1500	4000	—	V	D.C.

Specifications subject to change without notice.

TYPICAL OPTO-ISOLATOR CHARACTERISTIC CURVES

FIGURE 1. INPUT CHARACTERISTICS

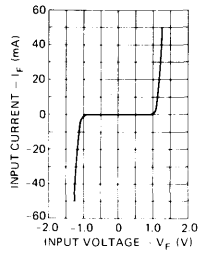

FIGURE 2. TRANSFER CHARACTERISTICS

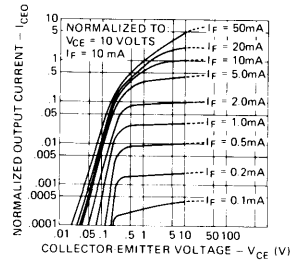

FIGURE 3. OUTPUT VS. INPUT CURRENT

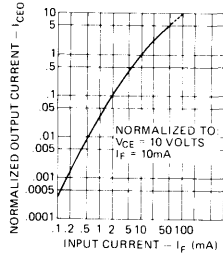

FIGURE 4. OUTPUT CHARACTERISTICS

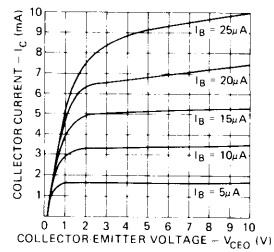

FIGURE 5. DARK CURRENT VS. TEMPERATURE

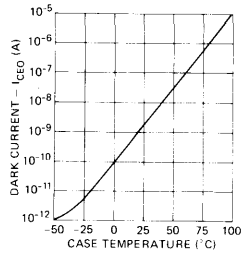
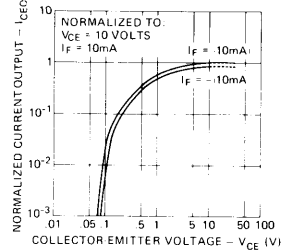
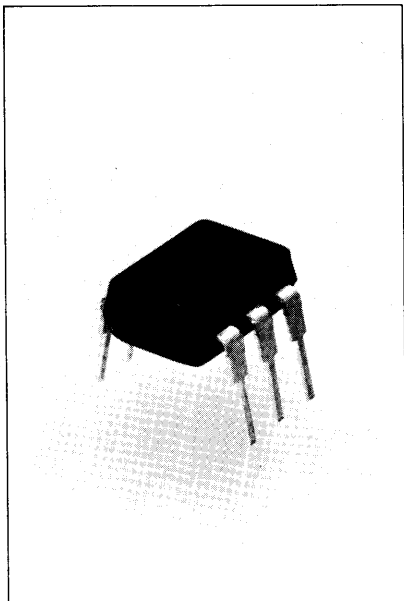

FIGURE 6. SYMMETRY CHARACTERISTICS



**BIDIRECTIONAL INPUT
OPTO-ISOLATOR**



FEATURES

- AC or Polarity Insensitive Input
- 5000 Volt Breakdown Voltage
- High Current-Transfer-Ratio (>50% min.)
- Industry Standard Dual-In-Line
- Built-in Reverse Polarity Input Protection
- Underwriters Lab Approval #E52744

DESCRIPTION

The IL250 is a bidirectional input opto-isolator. It consists of two gallium arsenide infrared emitting diodes coupled to a silicon NPN phototransistor in a 6 pin dual in-line plastic package.

Package Dimensions in Inches (mm)

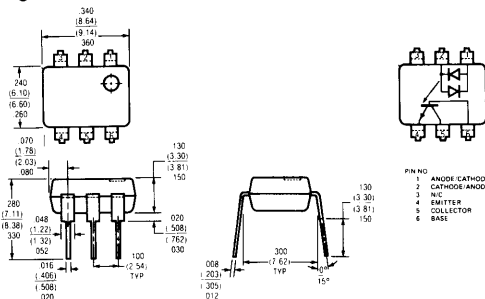

Maximum Ratings

- Gallium Arsenide LED**
- Power Dissipation @ 25°C 200 mW
 - Derate Linearly from 25°C 2.6 mW/°C
 - Continuous Forward Current 100 mA
 - Peak Inverse Voltage 3.0 V
- Detector (Silicon Phototransistor)**
- Power Dissipation @ 25°C 200 mW
 - Derate Linearly From 25°C 2.6 mW/°C
 - Collector-Emitter Breakdown Voltage (BV_{CEO}) 30 V
 - Emitter-Base Breakdown Voltage (BV_{ECO}) 5 V
 - Collector-Base Breakdown Voltage (BV_{CBO}) 70 V

- Package**
- Total Package Dissipation at 25°C Ambient (LED Plus Detector) 250 mW
 - Derate Linearly From 25°C 3.3 mW/°C
 - Storage Temperature -55 to +150°C
 - Operating Temperature -55 to +100°C
 - Lead Soldering Time @ 260°C 10 sec

Electrical Characteristics (25°C unless otherwise specified)

Parameter	Min	Typ	Max	Unit	Test Condition
Gallium Arsenide LED					
Forward Voltage V _F		1.2	1.5	V	I _F = ± 10 mA
Phototransistor Detector					
H _{FE}	100	200			V _{CE} = 5V I _C = 100 μA
BV _{CEO}	30	50		V	I _C = 1 mA
BV _{ECO}	7	10		V	I _C = 100 μA
BV _{CBO}	70	90		V	I _C = 10 μA
I _{CEO}		5	50	nA	V _{CE} = 10 V
Coupled Characteristics					
V _{CE(set)}			0.4	V	I _F = ± 16 mA I _C = 2 mA
DC Current Transfer Ratio (CTR)					
	50	150		%	I _F = ± 10 mA V _{CE} = 10 V
Symmetry					
CTR @ +10 mA	0.33	1.0	3.0		
CTR @ -10 mA					
Input to Output					
Isolation Voltage	5000			V	D.C.

TYPICAL OPTO-ISOLATOR CHARACTERISTIC CURVES

FIGURE 1. INPUT CHARACTERISTICS

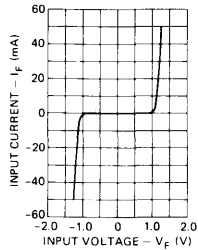

FIGURE 2. TRANSFER CHARACTERISTICS

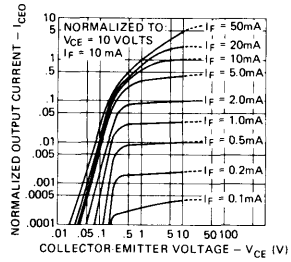

FIGURE 3. OUTPUT VS. INPUT CURRENT

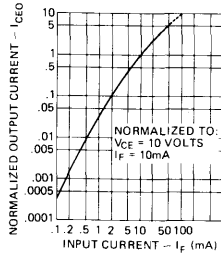

FIGURE 4. OUTPUT CHARACTERISTICS

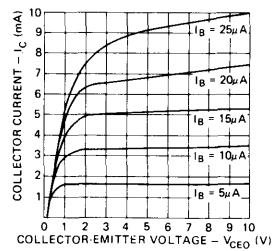

FIGURE 5. DARK CURRENT VS. TEMPERATURE

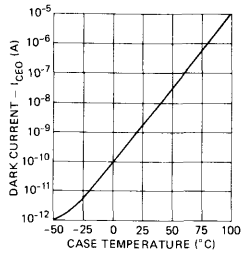
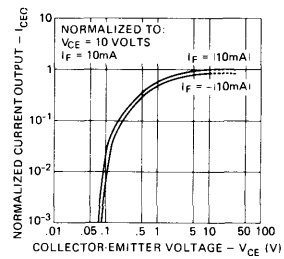
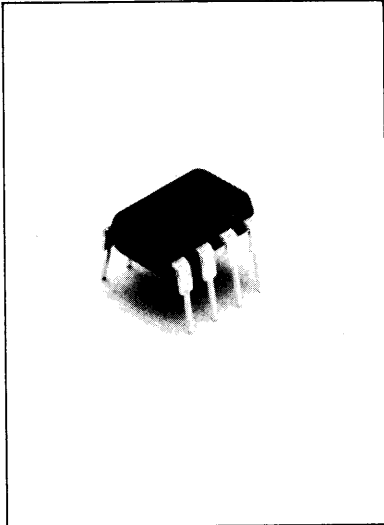

FIGURE 6. SYMMETRY CHARACTERISTICS



**VERY HIGH SPEED
THREE STATE
OPTO-ISOLATOR**



FEATURES

- Very High Speed — 65 n-sec typ. prop. delay
- Faraday Shielded Photodetector for Improved Common Mode Rejection
- DTL/TTL Compatible -5V supply
- Three State Output Logic for Multiplexing
- Built-in Schmitt Trigger to Avoid Oscillation
- Underwriters Lab Approval #E52744

DESCRIPTION

IL-100 is an optically coupled pair employing a Gallium Arsenide Phosphide LED and a silicon monolithic integrated circuit including a photodetector. High speed digital information can be transmitted by the device while maintaining a high degree of electrical isolation between input and output. The IL-100 can be used to replace pulse transformers in many digital interface applications. A built-in Schmitt Trigger provides hysteresis to reduce the possibility of oscillation.

Package Dimensions (inches/mm)

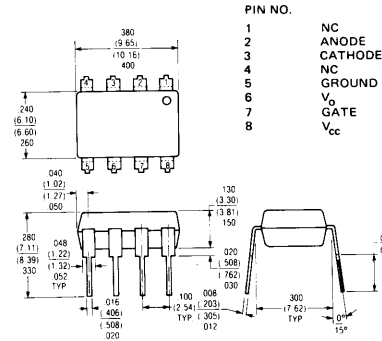

Recommended Operating Conditions

	Min.	Nom.	Max.	Units
Logical (1) Input Current - I _{in} (1)	0		10	mA
Supply Voltage - V _{cc}	4.5	5.0	5.5	V
Fan-Out - N (TTL Load)			10	—
Operating Temperature Range - T _A	0	25	70	°C

Absolute Maximum Ratings

Storage Temperature	-55°C to +125°C
Operating Temperature	0°C to +70°C
Lead Solder Temperature	260°C for 10 Sec.
Input Diode	
Forward DC Current	10 mA
Reverse Voltage	5V
Output - IC	
Supply Voltage - V _{cc}	7V
Enable Input Voltage - V _E	5.5V
	(Not to exceed V _{cc} by more than 500 mV)
Output Collector Current - I _C	100 mA
Output Collector Power Dissipation	100 mW
Output Collector Voltage - V _{OUT}	7V
Isolation Voltage (Input-Output)	2500V

Electrical Characteristics

Over Recommended Temperature (T_A = 0°C - 70°C)

Parameter	Min.	Typ.	Max.	Units	Test Conditions	Fig.	Note
I _{in} (1): Logic (1) Input Current to Ensure			5	mA		1.2	—
Logic (0) Output							
I _{in} (0): Logic (0) Input Current to Ensure							
Logic (1) Output			250	μA		1.2	—
V _G (1): Logic (1) Gate Voltage	2.0			V		—	—
V _G (0): Logic (0) Gate Voltage		.8		V		—	—
I _{out} (off)	-100μA		+100μA		V _{cc} = 5.5V, V ₀ = 1.5V V _G = 0V I _{in} = 0, 10mA	—	—

Specifications subject to change without notice.

Electrical Characteristics (Continued)
Over Recommended Temperature ($T_A = 0^\circ\text{C} - 70^\circ\text{C}$)

Parameter	Min.	Typ.	Max.	Units	Test Conditions	Fig.	Note
$V_{out}(0)$: Logic (0) Output Voltage	.35	.6		V	$V_{CC} = 5.5\text{V}$, $V_G = 2.4\text{V}$, $I_{in} = 5\text{ mA}$, $I_{out}(\text{Sinking}) = 16\text{ mA}$	—	—
$I_G(0)$: Logic (0) Gate Current	-1.6	-2.0		mA	$V_{CC} = 5.5\text{V}$, $V_G = 0.5\text{V}$	—	—
$I_G(1)$: Logic (1) Gate Current	0			mA	$V_{CC} = 5.5\text{V}$, $V_G = 2.4\text{V}$	—	—
$I_{CC}(1)$: Logic (1) Supply Current	18	22		mA	$V_{CC} = 5.5\text{V}$, $V_G = 0.5\text{V}$, $I_{in} = 0$	—	—
$I_{CC}(0)$: Logic (0) Supply Current	18	22		mA	$V_{CC} = 5.5\text{V}$, $V_G = 0.5\text{V}$, $I_{in} = 10\text{ mA}$	—	—
I_{CC}	13	16		mA	$V_{CC} = 5.5\text{V}$, $V_G = 2.4\text{V}$, $I_{in} = 0$	—	—
I_{CC}	17	21		mA	$V_{CC} = 5.5\text{V}$, $V_G = 2.4\text{V}$, $I_{in} = 10\text{ mA}$	—	—

Switching Characteristics at $T_A = 25^\circ\text{C}$, $V_{CC} = 5\text{V}$

Parameter	Min.	Typ.	Max.	Units	Test Conditions	Fig.	Note
$t_{pd}(1)$: Propagation Delay Time to Logical (1) Level	65	75		ns	$R_L = 350\Omega$, $C_L = 15\text{pF}$, $I_{in} = 7.5\text{ mA}$	—	1
$t_{pd}(0)$: Propagation Delay Time to Logical (0) Level	65	75		ns	$R_L = 350\Omega$, $C_L = 15\text{pF}$, $I_{in} = 7.5\text{ mA}$	—	2
$t_R \cdot t_F$: Output Rise-Fall Time (10-90%)	15			ns	$R_L = 350\Omega$, $C_L = 15\text{pF}$, $I_{in} = 7.5\text{ mA}$	—	—
$t_G(1)$: Propagation Delay Time of Gate from $V_G(1)$ to $V_G(0)$	15			ns	$R_L = 350\Omega$, $C_L = 15\text{pF}$, $I_{in} = 7.5\text{ mA}$, $V_G(1) = 2\text{V}$, $V_G(0) = 0.5\text{V}$	—	3
$t_G(0)$: Propagation Delay Time of Gate from $V_G(0)$ to $V_G(1)$	15			ns	$R_L = 350\Omega$, $C_L = 15\text{pF}$, $I_{in} = 7.5\text{ mA}$, $V_G(1) = 2\text{V}$, $V_G(0) = 0.5\text{V}$	—	4

Electrical Characteristics—Input-Output at $T_A = 25^\circ\text{C}$

Parameter	Symbol	Min.	Typ.	Max.	Units	Test Conditions	Fig.	Note
Insulation Voltage (Input-Output)	BV_{I-0}	2500			V		—	5
Resistance (Input-Output)	R_{I-0}	1012			Ω	$V_{I-0} = 500\text{V}$	—	5
Capacitance (Input-Output)	C_{I-0}	0.5	0.8		μF	$f = 1\text{MHz}$	—	5
Common Mode Rejection Voltage to Logical (0) Level	CMRV (1)	60			VAC p-p	$f = 10\text{MHz}$, $R_L = 350\Omega$, $V_{out}(\text{min.}) = 2\text{V}$, $I_{in} = 0\text{ mA}$	—	6
Common Mode Rejection Voltage to Logical (1) Level	CMRV (0)	60			VAC p-p	$f = 10\text{MHz}$, $R_L = 350\Omega$, $V_{out}(\text{max.}) = 0.6\text{V}$, $I_{in} = 7.5\text{ mA}$	—	6
Current Transfer Ratio	CTR	1000			%	$I_{in} = 5.0\text{ mA}$, $V_{CC} = 5\text{V}$, $R_L = 100\Omega$	—	7

Electrical Characteristics—Input Diode at $T_A = 25^\circ\text{C}$

Parameter	Symbol	Min.	Typ.	Max.	Units	Test Conditions	Fig.	Note
Forward Voltage	V_F	1.2	1.5	1.75	V	$I_{in} = 10\text{ mA}$	1	8
Reverse Break-down Voltage	V_{BR}	5			V	$I_R = 10\mu\text{A}$	—	—
Capacitance	C_{in}	25			pF	$V = 0$, $f = 1\text{MHz}$	—	—

Operating Procedures and Definitions

Logic Convention. The IL100 is defined in terms of positive logic.

Bypassing. A ceramic capacitor (.01 μF min.) should be connected from pin 8 to pin 5. Its purpose is to stabilize the operation of the switching amplifier. Failure to provide the bypassing may impair the switching properties.

Polarities. All voltages are referenced to network ground (pin 5). Current flowing toward a terminal is considered positive.

Gate Input. No external pull-up required for a logic (1).

NOTES:

- The $t_{pd}(1)$ propagation delay is measured from the 3.75 mA point on the trailing edge of the input pulse to the 1.5V point on the trailing edge of the output pulse.
- The $t_{pd}(0)$ propagation delay is measured from the 3.75 mA point on the input pulse to the 1.5V point on the leading edge of the output pulse.
- The $t_G(1)$ gate propagation delay is measured from the 1.5V point of the trailing edge of the input pulse to the 1.5V point on the trailing edge of the output pulse.
- The $t_G(0)$ gate propagation delay is measured from the 1.5V point on the input pulse to the 1.5V point on the leading edge of the output pulse. The input diode is DC biased to 10 mA [$I_{in}(1)$].
- Pins 2 and 3 shorted together, and pins 5, 6, 7, and 8 shorted together.
- CMRV (1) is the maximum tolerable common mode voltage to assure that the output will remain in a logic (1) state ($V_{out} > 2.0\text{V}$). CMRV (0) is the maximum tolerable common mode voltage to assure that the output will remain in a logic (0) state ($V_{out} < 0.6\text{V}$).
- DC Current Transfer Ratio is defined as the ratio of the output collector current to the forward bias input current times 100%.
- At 10 mA V_F decreases with increasing temperature at the rate of 1.6mV/ $^\circ\text{C}$.

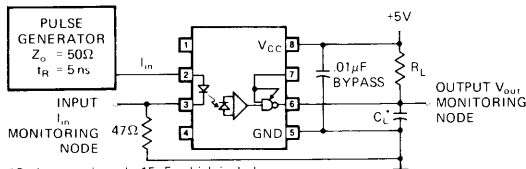

* C_L is approximately 15pF, which includes probe and stray wiring capacitance.

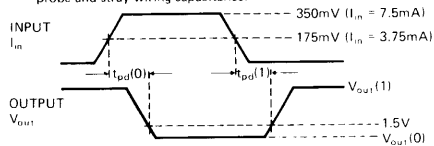

Test Circuit for $t_{pd}(0)$ and $t_{pd}(1)$.

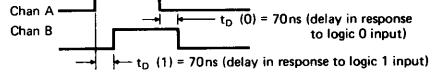
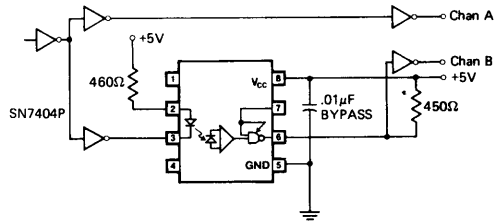

Response Delay Between TTL Gates.

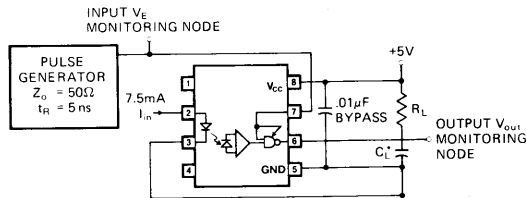

* C_L is approximately 15pF, which includes probe and stray wiring capacitance.

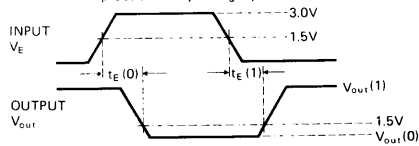

Test Circuit for $t_f(0)$ and $t_f(1)$.

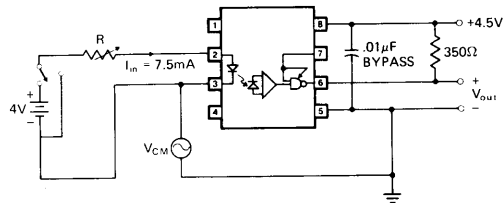
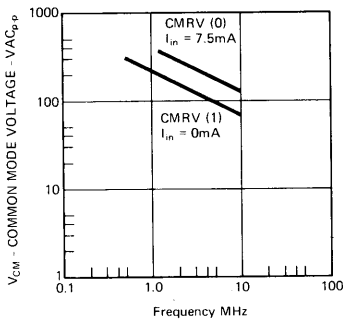

Typical Common Mode Rejection Characteristics/Circuit

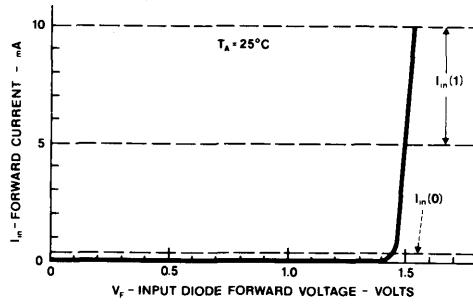
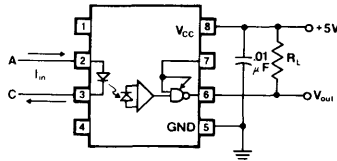
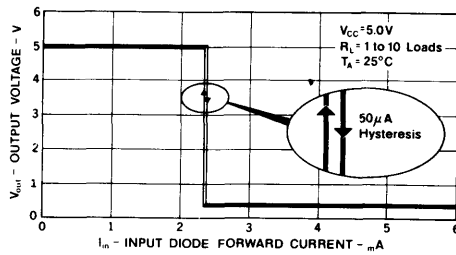

Figure 1

TRUTH TABLE (Positive Logic)

Input*	Enable	Output
1	1	0
0	1	1
1	0	off
0	0	off

*See definition of terms for logic state.



Input-Output Characteristics

Figure 2

**HIGH SPEED
THREE STATE
OPTO-ISOLATOR**

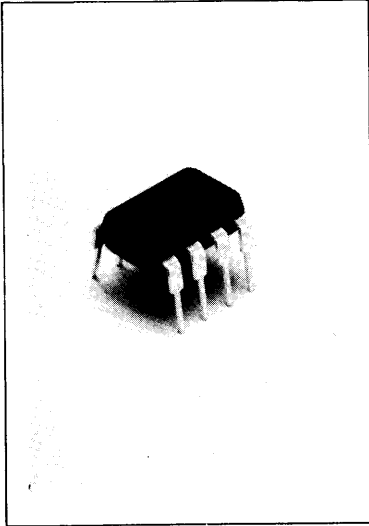

FEATURES

- High Speed – 100 n-sec typ. prop. delay
- Faraday Shielded Photodetector for Improved Common Mode Rejection
- DTL/TTL Compatible –5V supply
- Three State Output Logic for Multiplexing
- Built-in Schmitt Trigger to Avoid Oscillation
- Underwriters Lab Approval #E52744

DESCRIPTION

IL-101 is an optically coupled pair employing a Gallium Arsenide Phosphide LED and a silicon monolithic integrated circuit including a photodetector. High speed digital information can be transmitted by the device while maintaining a high degree of electrical isolation between input and output. The IL-101 can be used to replace pulse transformers in many digital interface applications. A built-in Schmitt Trigger provides hysteresis to reduce the possibility of oscillation.

Package Dimensions (inches/mm)

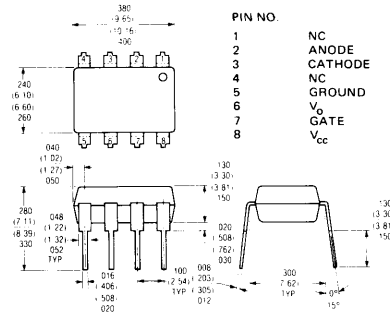

Absolute Maximum Ratings

Storage Temperature	-55°C to +125°C
Operating Temperature	0°C to +70°C
Lead Solder Temperature	260°C for 10 Sec.
Input Diode		
Forward DC Current	10 mA
Reverse Voltage	5V
Output - IC		
Supply Voltage - V _{CC}	7V
Enable Input Voltage - V _E	5.5V
		(Not to exceed V _{CC} by more than 500 mV)
Output Collector Current - I _C	100 mA
Output Collector Power Dissipation	100 mW
Output Collector Voltage - V _{OUT}	7V
Isolation Voltage (Input-Output) - DC	1500V

Electrical Characteristics

Over Recommended Temperature (T_A = 0°C – 70°C)

Parameter	Min.	Typ.	Max.	Units	Test	
					Conditions	Fig. Note
I _{in} (1): Logic (1) Input Current to Ensure						
Logic (0) Output	5			mA		1 -
I _{in} (0): Logic (0) Input Current to Ensure						
Logic (1) Output			250	μA		1 -
V _G (1): Logic (1) Gate Voltage	2.0			V		- -
V _G (0): Logic (0) Gate Voltage		.8		V		- -
V _{out} (0): Logic (0) Output Voltage	.35	6		V	V _{CC} = 5.5V, V _G = 2.4V, I _{in} = 5 mA, I _{out} (Sinking) = 16 mA	- -
I _{CC}	18	22		mA	V _{CC} = 5.5V V _G = 0.5V I _{in} = 0.10 mA	

Specifications subject to change without notice.

Switching Characteristics at $T_A = 25^\circ$, $V_{CC} = 5V$

Parameter	Min.	Typ.	Max.	Test		Fig.	Note
				Conditions	Units		
$t_{pd}(1)$: Propagation Delay Time to Logical (1) Level	100	200	ns	$R_L = 350\Omega$,	1	1	
				$C_L = 15pF$, $I_{in} = 7.5\text{ mA}$			
$t_{pd}(0)$: Propagation Delay Time to Logical (0) Level	100	200	ns	$R_L = 350\Omega$,	1	2	
				$C_L = 15pF$, $I_{in} = 7.5\text{ mA}$			
t_{R-F} : Output Rise-Fall Time (10-90%)	15		ns	$R_L = 350\Omega$, $C_L = 15pF$, $I_{in} = 7.5\text{ mA}$	-	-	

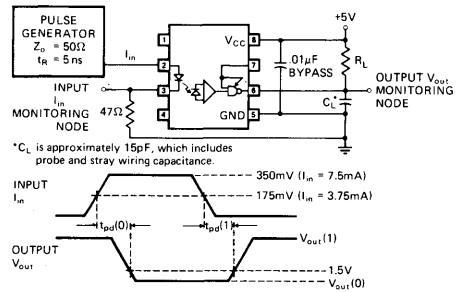

Test Circuit for $t_{pd}(0)$ and $t_{pd}(1)$.

Fig. 1

Electrical Characteristics—Input-Output at $T_A = 25^\circ C$

Parameter	Symbol	Min.	Typ.	Max.	Test		Fig.	Note
					Conditions	Units		
Insulation Voltage (Input-Output)	V_{1-0}	1500		V	-	3		
Resistance (Input-Output)	R_{1-0}	10^{12}		Ω	$V_{1-0} = 500V$	-	3	
Capacitance (Input-Output)	C_{1-0}	0.5	0.8	pF	$f = 1\text{ MHz}$	-	3	

TRUTH TABLE (Positive Logic)

Input*	Enable	Output
1	1	0
0	1	1
1	0	off
0	0	off

*See definition of terms for logic state.

Electrical Characteristics—Input Diode at $T_A = 25^\circ C$

Parameter	Symbol	Min.	Typ.	Max.	Test		Fig.	Note
					Conditions	Units		
Forward Voltage	V_F	1.2	1.5	1.75	V	$I_{in} = 10\text{ mA}$	-	4
Reverse Break-down Voltage	V_{BR}	5		V	$I_R = 10\mu A$	-	-	
Capacitance	C_{in}	10		pF	$V = 0$, $f = 1\text{ MHz}$	-	-	

Operating Procedures and Definitions

Logic Convention. The IL-101 is defined in terms of positive logic.

Bypassing. A ceramic capacitor (.01 μF min.) should be connected from pin 8 to pin 5. Its purpose is to stabilize the operation of the switching amplifier. Failure to provide the bypassing may impair the switching properties.

Polarities. All voltages are referenced to network ground (pin 5). Current flowing toward a terminal is considered positive.

Gate Input. No external pull-up required for a logic (1).

NOTES:

- The $t_{pd}(1)$ propagation delay is measured from the 3.75 mA point on the trailing edge of the input pulse to the 1.5V point on the trailing edge of the output pulse.
- The $t_{pd}(0)$ propagation delay is measured from the 3.75 mA point on the input pulse to the 1.5V point on the leading edge of the output pulse.
- Pins 2 and 3 shorted together, and pins 5, 6, 7, and 8 shorted together.
- At 10 mA V_F decreases with increasing temperature at the rate of 1.6mV/ $^\circ C$.

DUAL PHOTOTRANSISTOR OPTO-ISOLATOR

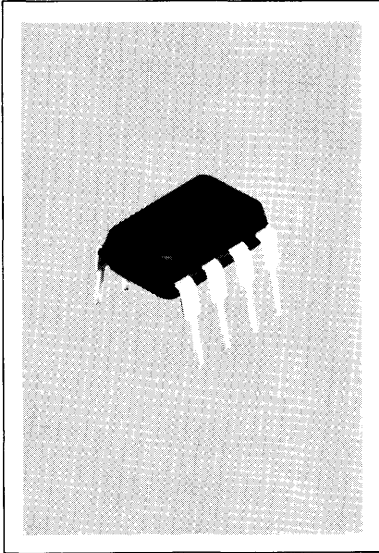

Package Dimensions in Inches (mm)

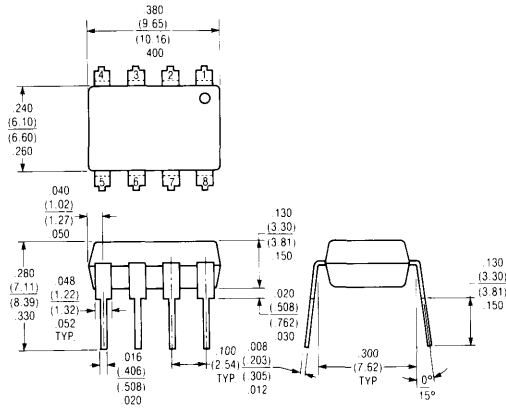

Pin Configuration

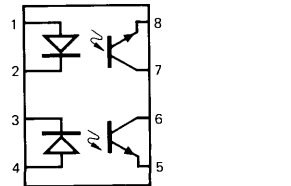

LED CHIPS ON PINS 2 AND 3
PT CHIPS ON PINS 6 AND 7

PIN NO.	FUNCTION
1	ANODE
2	CATHODE
3	CATHODE
4	ANODE
5	EMITTER
6	COLLECTOR
7	COLLECTOR
8	EMITTER

FEATURES

- Two Isolated Channels Per Package
- 1500V Isolation
- 50% Typical Current Transfer Ratio
- 1 nA Typical Leakage Current
- Direct Replacement For MCT6
- Underwriter Lab Approval #E52744

DESCRIPTION

The IL-CT6 is a two channel opto isolator for high density applications. Each channel consists of an optically coupled pair employing a Gallium Arsenide infrared LED and a silicon NPN phototransistor. Signal information, including a DC level, can be transmitted by the device while maintaining a high degree of electrical isolation between input and output. The IL-CT6 is especially designed for driving medium-speed logic, where it may be used to eliminate troublesome ground loop and noise problems. It can also be used to replace relays and transformers in many digital interface applications, as well as analog applications such as CRT modulation.

MAXIMUM RATINGS

Maximum Temperatures	
Storage Temperature	-55°C to +150°C
Operating Temperature	-55°C to +100°C
Lead Temperature (Soldering, 10 seconds)	260°C
Input Diode (each channel)	
Rated Forward Current, DC	60 mA
Peak Forward Current (1μs pulse, 300 pps)	3 A
Power Dissipation at 25°C Ambient	100 mW
Derate Linearly From 25°C	1.3 mW/°C
Output Transistor (each channel)	
Power Dissipation @ 25°C Ambient	150 mW
Derate Linearly From 25°C	2 mW/°C
Collector Current	30 mA
Coupled	
Input to Output Breakdown Voltage	1500 Volts DC
Total Package Power Dissipation @ 25°C Ambient	400 mW
Derate Linearly From 25°C	5.33 mW/°C

ELECTRO-OPTICAL CHARACTERISTICS (25°C Free Air Temperature Unless Otherwise Specified)

Parameter	Min	Typ	Max	Units	Test Conditions
Input Diode					
Rated Forward Voltage		1.25	1.50	V	$I_F = 20 \text{ mA}$
Reverse Voltage	3.0	5.0		V	$I_R = 10 \mu\text{A}$
Reverse Current		0.001	10	μA	$V_R = 3.0 \text{ V}$
Junction Capacitance		100		pF	$V_F = 0\text{V}$
Output Transistor					
Breakdown Voltage,					
Collector to Emitter	30	65		V	$I_C = 1.0 \text{ mA}$
Emitter to Collector	7.0	10		V	$I_C = 100 \mu\text{A}$
Leakage Current,		1.0	100	nA	$V_{CE} = 10\text{V}$
Collector to Emitter					
Capacitance Collector to Emitter		8.0		pF	$V_{CE} = 0\text{V}$
Coupled					
DC Current Transfer Ratio (I_C/I_F)	20	50		%	$V_{CE} = 10 \text{ V}, I_F = 10 \text{ mA}$
Saturation Voltage – Collector to Emitter			0.40	V	$I_C = 2.0 \text{ mA}, I_F = 16 \text{ mA}$
Isolation Voltage	1500	2500		VDC	$t = 1 \text{ Minute}$
Isolation Resistance		10^{11}		Ω	$V_{I-O} = 500 \text{ V}$
Isolation Capacitance		0.5		pF	$f = 1.0 \text{ MHz}$
Breakdown Voltage – Channel-to-Channel		1500		V	Relative Humidity = 40%
Capacitance Between Channels		0.4		pF	$f = 1.0 \text{ MHz}$
Bandwidth		150		KHz	$I_C = 2.0 \text{ mA}, V_{CC} = 10\text{V}$ $R_L = 100 \Omega$
Switching Times, Output Transistor					
Non-Saturated Rise Time, Fall Time		2.4		μs	$I_C = 2.0 \text{ mA}, V_{CE} = 10\text{V}$ $R_L = 100 \Omega$
Non-Saturated Rise Time, Fall Time		15		μs	$I_C = 2.0 \text{ mA}, V_{CE} = 10\text{V}$ $R_L = 1.0 \text{ K}\Omega$
Saturated Turn-On Time (From 5.0 V to 0.8 V)		5.0		μs	$R_L = 2.0 \text{ k}\Omega, I_F = 15 \text{ mA}$
Saturated Turn-Off Time (From Saturation to 2.0V)		25		μs	$R_L = 2.0 \text{ K}\Omega, I_F = 15 \text{ mA}$

Specifications subject to change without notice.

TYPICAL OPTO-ELECTRONIC CHARACTERISTIC CURVES FOR EACH CHANNEL

FIGURE 1. I-V CURVE OF PHOTOTRANSISTOR

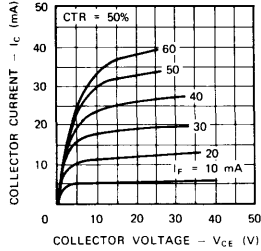

FIGURE 2. I-V CURVE IN SATURATION

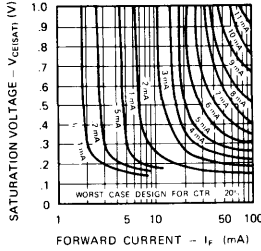

FIGURE 3. CTR VS FORWARD CURRENT

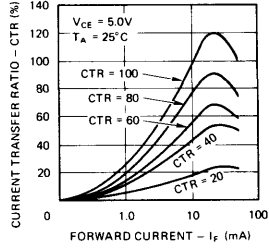

FIGURE 4. CURRENT TRANSFER RATIO VS TEMPERATURE

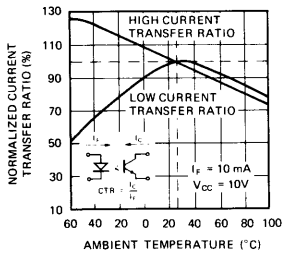

FIGURE 5. I-V CURVE OF LED VS TEMPERATURE

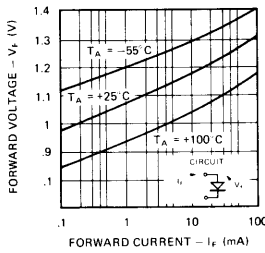

FIGURE 6. LEAKAGE CURRENT VS TEMPERATURE VS COLLECTOR VOLTAGE

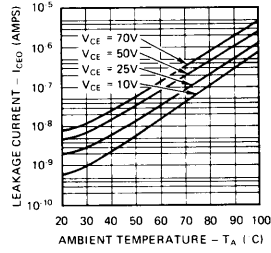
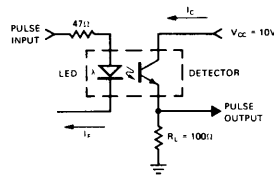
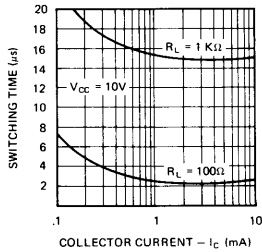

FIGURE 7. SWITCHING TIME VS COLLECTOR CURRENT



CIRCUIT USED TO OBTAIN SWITCHING TIME VS COLLECTOR CURRENT PLOT

LED'S & PHOTOMETRY

by George Smith

The observed spectrum of electromagnetic radiations, extends from a few Hz, to beyond 10^{24} Hz, covering some 80 octaves. The narrow channel from 430 THz to 750 THz would be entirely negligible, except for the fact that more information is communicated to human beings, in this channel, than is obtained from the rest of the spectrum. This radiation has a wavelength ranging from 400nm to 700nm, and is detectable by the sensory mechanisms of the human eye. Radiation observable by the human eye is commonly called light.

Measurements of the physical properties of light and light sources, can be described in the same terms as any other form of electromagnetic energy. Such measurements are commonly called Radiometric Measurements.

Measurements of the psychophysical attributes of the electromagnetic radiation we call light, are made in terms of units, other than these radiometric units. Those attributes which relate to the luminosity (sometimes called visibility) of light and light sources, are called photometric quantities, and the measurement of these aspects is the subject of Photometry.

The electronics engineer who is starting to apply light emitting diodes and other opto-electronic devices to perform useful tasks, will find the subject of photometry to be a confused mass of strange units, confusing names for photometric quantities, and general disagreement as to what the important requirements are for his application.

The photometric quantities are related to the corresponding radiometric quantities by the C.I.E. Standard Luminosity Function (Fig. 1), which we may colloquially refer to as the standard eyeball. We can think of the luminosity function, as the transfer function of a filter which approximates the behavior of the average human eye under good lighting conditions.

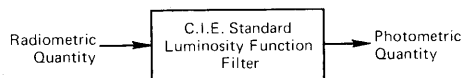

Figure 1. Relationship between radiometric units and photometric units.

The eye responds to the rate at which radiant energy falls on the retina, i.e., on the radiant flux density expressed as Watts/m². The corresponding photometric quantity is Lumens/m². The standard luminosity function is then, a plot of Lumens/Watt as a function of wavelength.

The function has a maximum value of 680 Lumens/Watt at 555nm and the ½ power points occur at 510nm and 610nm (Fig. 2).

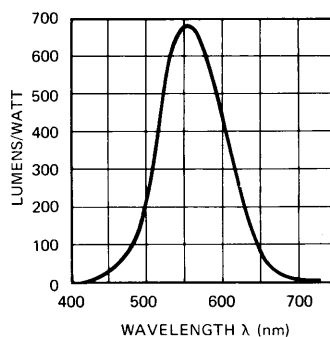

Figure 2. CIE standard photopic luminosity function.

The LUMEN is the unit of LUMINOUS FLUX and corresponds to the watt as the unit of radiant flux.

Thus the total luminous flux emitted by a light source in all directions is measured in lumens, and can be traced back to the power consumed by the source to obtain an efficiency number.

Since it is generally not practical to collect all the flux from a light source, and direct it in some desired direction, it is desirable to know how the flux is distributed spatially about the source. If we treat the source as a point (far field measurement), we can divide the space around the source into elements of solid angle ($d\omega$), and inquire as to the luminous flux (dF) contained in each element of solid angle ($\frac{dF}{d\omega}$). The resulting quantity is Lumens/Steradian and is called LUMINOUS INTENSITY (I), (Fig. 3). The unit of Luminous intensity is called the CANDELA, sometimes loosely called the candle, or candle power.

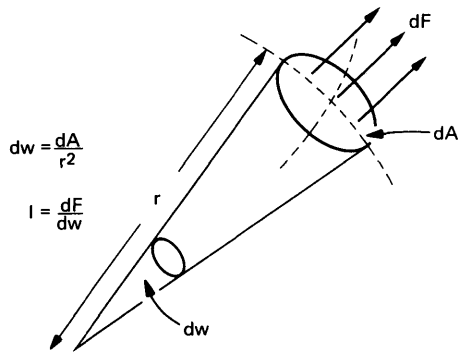

Figure 3. Solid angles and luminous intensity.

Since the space surrounding a point contains 4π steradians, it is apparent that an isotropic radiator of one candela intensity, emits a total luminous flux of 4π Lumens.

No real light source is isotropic, so it is quite common to show a plot of Luminous intensity versus angle off the axis (Fig. 4). If the source has no axis of symmetry, a more complex diagram is required.

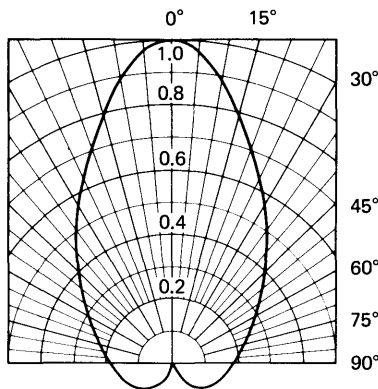

Figure 4. Spatial distribution pattern.

For an extended radiating surface, (such as an LED chip), each element of area contributes to the luminous intensity of the source, in any given direction. The luminous intensity contribution in the given direction, divided by the projected area of the surface element in that direction, is called the LUMINANCE (B) of the source (in that direction), (Fig. 5). The quantity is sometimes called photometric brightness, or simply brightness. The use of the term brightness on its own, should be discouraged, as this involves various subjective properties such as texture, color, sparkle, apparent size, etc. that have psychological implications.

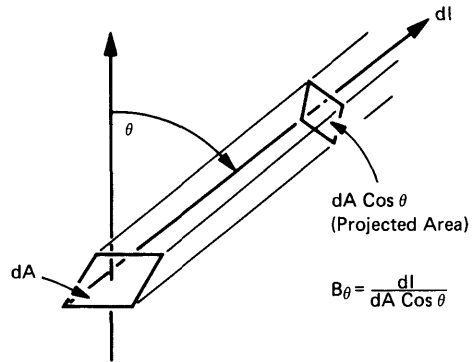

Figure 5. Definition of luminance.

The fundamental quantitative standard of the photometric system of units is the standard of luminance.

The luminance of a black body radiator at the temperature of freezing platinum (2043.8°K) is 60 candela per square centimeter. [A blackbody radiator is a perfect absorber of all electromagnetic energy incident on it. In thermal equilibrium at a given temperature, it emits radiation, spectrally distributed according to Planck's Formula

$$(W_\lambda = \frac{c_1 \lambda^{-5}}{\exp(\frac{c_2}{\lambda}) - 1})$$

The units of Luminance in present use are an engineering nightmare.

1 candela/cm² is called a *Stilb*

1/π candela/cm² is called a *Lambert*

1 candela/m² is called a *Nit*

1/π candela/m² is called an *Apostilb*

1/π candela/ft² is called a *foot-Lambert*

The foot Lambert is the most commonly used unit in this country.

Of particular interest is a source whose angular distribution pattern is a circle (Fig. 6). For such a source we have $I_\theta = I_0 \cos \theta$, the luminance of such a source in a given direction θ , is then given by

$$B_\theta = \frac{d I_\theta}{d A \cos \theta} = \frac{d I_0 \cos \theta}{d A \cos \theta} = \frac{d I_0}{d A}$$

The luminance is seen to be the same in all directions. Such a source is called a LAMBERTIAN SOURCE. It can be shown that a perfectly diffusing surface behaves in this fashion. The formula governing a diffusing surface $I_\theta = I_0 \cos \theta$ is called Lambert's Cosine Law.

It can be shown that a flat LED chip is a very good approximation to a Lambertian Source.

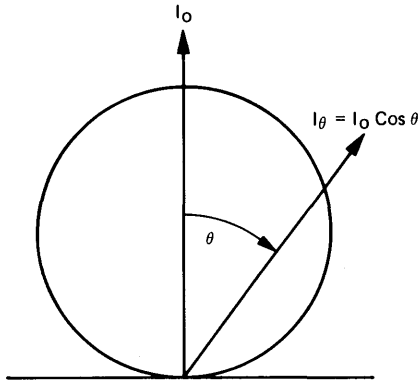

Figure 6. Lambertian radiation pattern.

If we now take a surface element (dA) and determine the intensity contribution in each direction we can determine the total flux (dF) emitted by the surface element. The resultant ratio ($\frac{dF}{dA}$) Lumens/ m^2 is called the LUMINOUS EMITTANCE (L). For a flat surface we may calculate L from

$$L = 2\pi \int_0^{\pi/2} B(\theta) S_{IN} \theta \cos \theta d\theta$$

The corresponding radiant emittance in watts/ m^2 is of considerable interest for GaAs infrared LED's where total output power is an important parameter.

The total luminous flux emitted by a light source can then be calculated from $F_{total} = \int LdA$.

These photometric quantities are sufficient to describe the properties of light sources such as light emitting diodes.

When light falls on a receiving surface, it is either partially reflected in the case of a purely passive surface, or partly converted into some other form of energy by what we may describe as an active surface (such as a phototransistor or photomultiplier cathode). In either case we are interested in how much flux falls on each element of the surface; Lumens/ m^2 in the case of a passive surface which we wish to illuminate, or the eye; and Watts/ m^2 in the case of other active surfaces. The quantity Lumens/ m^2 in this case is called the ILLUMINANCE sometimes loosely referred to as the illumination. The unit of illuminance is the LUX also referred to as the metercandle. Another commonly used unit of illuminance, in this country is the FOOT CANDLE, equal to one lumen per square foot. One lumen per square cm is called a PHOT.

Many of these photometric quantities and units are in common use in the field of illumination engineering, with the English units being most common in this country. It should be apparent to the reader that a mixed system of units is involved in common usage.

APPLICATION TO LIGHT EMITTING DIODES

The above description of photometric quantities should indicate to the reader that there are many ways in which the photometric properties of LED's can be stated. There is no general agreement among LED makers and users, as to the best way to specify LED performance, and this has led to much confusion and misunderstanding.

Many factors must be taken into account when evaluating LED specifications for a particular application, and electronic engineers will need to develop a knowledge of these factors to put LED's to effective use in new designs.

Presently available light emitting diodes are made from the so-called III-V compound semiconductors, with Gallium Arsenide Phosphide and Gallium Phosphide being the major materials. Gallium Aluminum Arsenide is also used but is less common. Gallium Arsenide is commonly included in this group, but it should be remembered that GaAs emits only infra-red radiation around 900nm, which is not visible to the eye, and is thus not properly called light. All specifications of GaAs emitters must be in radiometric units.

GaP emits green light between 520 and 570nm peaking 550nm very close to the peak eye sensitivity. It also can emit red light between 630 and 790nm peaking at 690nm.

$GaAs_{(1-x)}P_x$ emits light over a broad orange red range depending on the percentage of GaP in the material (x). For x in the 0.4 region, red light between 640 and 700nm peaking at 660nm, is obtained. For $x = 0.5$, amber light peaking around 610nm is obtained.

$Ga_{(1-x)}Al_xAs$ as presently available, emits red light between 650 and 700nm peaking at 670nm.

The efficiency of these materials is very dependent on the emitted wavelength, with drastic fall off in efficiency as the wavelength gets shorter. Fortunately the standard eyeball filter, favors the shorter wavelength (down to 555nm) and gives some measure of compensation. Some typical efficiencies reported by device makers, and the resulting overall luminous efficiency (Lumens/electrical watt) are as follows:

GaP,red	.72% @ 20Lum/Watt =
	.14 Lum/Watt overall (Opcoa)
GaAs _{0.6} P _{0.4} red	.3% @ 50Lum/Watt =
	.15 Lum/Watt overall (Litronix)
GaAlAs red	.06% @ 40Lum/Watt =
	.024 Lum/Watt overall (Mitsubishi)
GaP green	.006% @ 675Lum/Watt =
	.04 Lum/Watt overall (Monsanto)
GaAs _{0.5} P _{0.5} amber	.0044% @ 340Lum/Watt -
	.015 Lum/Watt overall (Monsanto)

For simple status indicator applications, front panel lamps and similar applications, several factors must be taken into account:

- (1) Color. Generally the designer has Henry Ford's color choice; various similar shades of red. Amber and green are available in small quantity, because of availability of suitable raw material.
- (2) Apparent source size. Various combinations of chip size and optical systems are available so that apparent source sizes from about 5 mils to about 300 mils diameter are available as standard products. Other things being equal, a larger source size is more visible.
- (3) Angular distribution. GaAsP diode chips are nearly Lambertian, but GaP are nearly isotropic. With suitable optical design, the angular distribution pattern can be changed from very broad to quite narrow. By placing the chip at the focus of the lens system a narrow high intensity beam is obtained. The off axis visibility is drastically reduced. By using diffusing lens materials, a large area source with good off axis visibility is obtained. In this case the luminance is reduced.
- (4) Luminous intensity. This will govern the visibility under optimum background contrast conditions, when viewed at normal distances. 1 millicandela is typical for red lamps of either GaAsP or GaP at normal operating conditions.
- (5) Luminance. When it is not possible to provide a dark contrasting background, or when the source is viewed at very close distances, the luminance becomes important. Values from 100 ft-L to 5000 ft-L are typical.

These factors are all related to the design of the device and the user should understand the trade offs. High luminance values in excess of 10,000 ft-L are easily obtained by running very high current densities in the LED chip, but this can lead to shortened life if carried too far.

For a given drive current the luminous intensity of two different chips will be similar, while the luminance will be inversely proportional to the active area of the chip.

If the designer can use filter screens or circularly polarizing filters in front of the light source, excellent protection from background illumination can be

obtained. In this case a diffusive lens giving a large apparent source with lower luminance, is more visible than a high luminance point source.

When a LED is used with an optical system to activate a remote sensor such as a cadmium sulphide or cadmium selenide cell (red light), or a GaAs IR emitter is used with a silicon photo detector, the performance requirements are somewhat different. It can be shown that for a given optical arrangement the irradiance of the detector determines the detected signal and this is proportional to the radiance of the source, which is comparable to the luminance (brightness) of the source. The intensity of the source will not be a factor unless the detector active area is larger than the incident beam.

When average power consumption must be minimized but good visibility is required, or detection at a considerable distance is required, pulsed operation can be used. With GaAs and GaAsP emitters using low duty cycle short pulses, very high peak intensity levels can be reached permitting communication over considerable distances. This technique is not useful with GaP diodes since they do not exhibit a linear relationship between optical output and instantaneous forward current, becoming saturated at moderate current levels. GaP also has a 50% higher rate of fall off in light output with temperature increase, than GaAsP which further inhibits high power applications.

The use of LED's to give a "Heads Up" projected display, such as for an automobile speedometer read-out, or aircraft cockpit application, places severe requirements on the display luminance. For easy visibility, the projected image must be sufficiently contrasted with the ambient illumination. This requires very high luminance values for the LED's together with the use of photochromic windshields and probably polarizing screens.

The foregoing is a necessarily simplified, description of a very complex subject. The reader should avail himself of the standard textbook literature on these subjects.

References:

- R. Kingslake, *Applied Optics & Optical Engineering*
Committee on Colorimetry of the O.S.A., *The Science of Color*.
Warren J. Smith, *Modern Optical Engineering*.

APPLICATIONS OF OPTO-ISOLATORS

by George Smith

The Litronix Iso-Lit 1 is the first in a family of Opto-isolators. These products are also called photon coupled isolators, photo-couplers, photo-coupled pairs and optically coupled pairs. All of the characteristics of the Iso-Lit 1 are electrical: it has no external optical properties. Hence opto-isolators are not OPTO-ELECTRONIC DEVICES; they are in fact one of the simplest of all ELECTRO-OPTICAL SYSTEMS.

The Iso-Lit 1 consists of a Gallium Arsenide infrared emitting diode, and a silicon phototransistor mounted together in a DIP package.

When forward current (I_F) is passed through the Gallium Arsenide diode, it emits infrared radiation peaking at about 900nm wavelength. This radiant energy is transmitted through an optical coupling medium and falls on the surface of the NPN phototransistor.

Photo-transistors are designed to have large base areas; and hence a large base-collector junction area; and a small emitter area. Some fraction of the photons that strike the base area cause the formation of electron-hole pairs in the base region. This fraction is called the QUANTUM EFFICIENCY of the photo-detector.

If we ground the base and emitter, and apply a positive voltage to the collector of the photo-transistor, the device operates as a photo diode.

The high field across the collector base junction quickly draws the electrons across into the collector region. The holes drift towards the base terminal attracting electrons from the terminal.

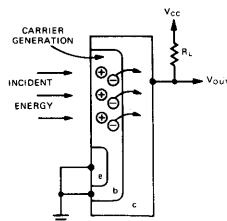

Thus a current flows from collector to base, causing a voltage drop across the load resistance (R_L).

The high junction capacitance, C_{cb} , results in an output circuit time constant $R_L C_{cb}$, with a corresponding output voltage rise time.

The output current in this configuration is quite small and hence this connection is not normally used.

The commonest circuit configuration is to leave the base connection open. With this connection, the holes generated in the base region cause the base potential to rise, forward biasing the base-emitter junction. Electrons are then injected into the base from the emitter, to try to neutralize the excess holes. Because of the close proximity of the collector junction, the probability of an electron recombining with a hole is small and most of the injected electrons are immediately swept into the collector region. As a result, the total collector current is much higher than the photo-generated current, and is in fact β times as great.

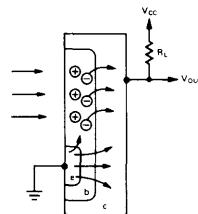

The total collector current is then several hundred times greater than for the previous connection.

This gain comes with a penalty of much slower operation. Any drop in collector voltage is coupled to the base via the collector-base capacitance tending to turn off the injected current. The only current available to charge this junction capacitance is the original photo-current. Thus, the rate of change of the output voltage is the same for both the diode and transistor connections. In the latter case, the voltage swing is β times as great, so the total rise time is β times as great as for the diode connection. Thus the effective output time constant is $\beta R_L C_{cb}$.

For the Iso-Lit 1 this results in a typical $2 \mu s$ rise time for 100Ω load.

The ratio of the output current from the photo-transistor (I_C or I_E), to the input current in the Gallium Arsenide diode, is called the Current Transfer Ratio (CTR). For the Iso-Lit 1 CTR is specified at 20% minimum with 35% being typical at $I_F = 10 \text{ mA}$.* Thus for 10 mA input current the minimum output current is 2 mA. Other important parameters are V_F typically 1.3V at 100 mA I_F .

*NOTE: CTR values of 50% and higher are available from the factory.

DIGITAL INTERFACES

Output Sensing Circuits

The output of the photo-transistor can directly drive the input of standard logic circuits such as the 930 DTL and 7400 TTL families. The worst case input current for the 74 series gate is -1.6 mA for $V_{IN} = 0.4 \text{ Volts}$. This can be easily supplied by the Iso-Lit 1, with 10 mA input to the infrared diode.

DTL or TTL Active Level Low (930 or 7400)

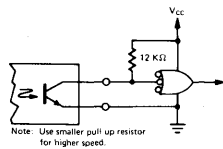

RTL Active Level Low ($\mu 914$)

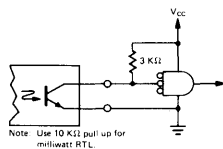

RTL Active Level High ($\mu 914$)

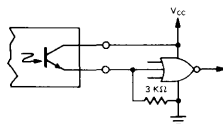

It is more difficult to operate into DTL and TTL gates in the active level high configuration. Some possible methods are as follows;

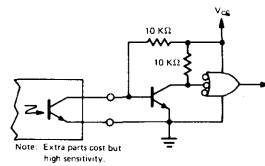
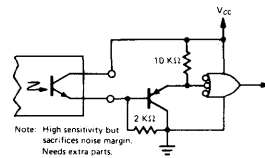
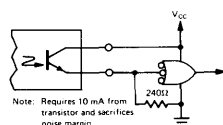
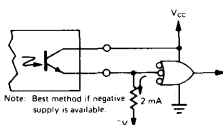

Obviously, several Iso-Lit output transistors can be connected to perform logical functions.

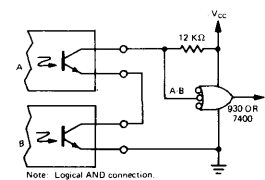
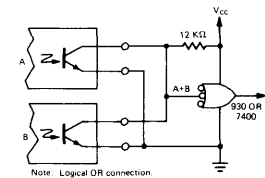

Input Driving Circuits

The input side of the Iso-Lit 1 has a diode characteristic as shown.

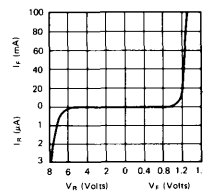

The forward current must be controlled to provide the desired operating condition.

The input can be conveniently driven by integrated circuit logic elements in a number of different ways.

DTL Active Level High (930 Series)

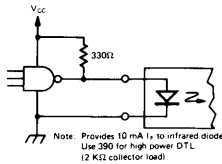

DTL Active Level Low (930 Series)

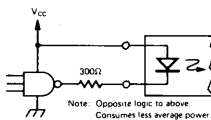

TTL Active Level High (7400 Series)

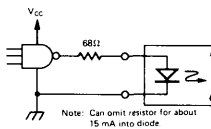

TTL Active Level Low (7400 Series)

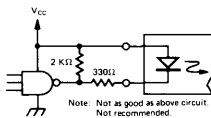
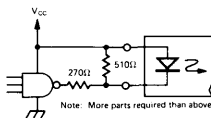

There are obviously many other ways to drive the device with logic signals, but the commonest needs can be met with the above circuits. All provide 10 mA into the LED giving 2 mA minimum out of the photo-transistor. The 1 Volt diode knee and its high capacitance (typically 100 pF), provides good noise immunity. The rise time and propagation delay can be reduced by biasing the diode on to perhaps 1 mA forward current, but the noise performance will be worse.

All previous configurations show medium speed digital interfaces. These circuits have various advantages over other ways of doing the task.

(1) They can replace relays and reed relays, giving much faster switching speeds, no contact bounce, better reliability, and usually better electrical isolation except for special configurations. However relays have high current capability, higher output voltage, lower on resistance and offset voltage and higher off resistance.

(2) They can replace pulse transformers in many floating applications. Opto-isolators can transmit DC signal components and low frequency AC, whereas pulse transformers couple only the high frequency components, and a latch is required to restore the DC information. Pulse transformers have faster rise time than photo-transistor opto-isolators.

(3) Integrated circuit line drivers and receivers are used to transmit digital information over long lines in the presence of common mode noise. The maximum common mode noise voltage permissible is usually in the 30 Volt range. There are many practical situations where common mode noise voltages of several hundred Volts can be induced in long lines. For these applications opto-isolators provide protection against several thousand Volts.

LINEAR APPLICATIONS

The curve of input current versus output current for the Iso-Lit 1 is somewhat non-linear, because of the variation of β with current for the photo-transistor, and the variation of infrared radiation out versus forward current in the GaAs diode. The useful range of input current is about 1 mA to 100 mA, but higher currents may be used for short duty cycles.

For linear applications the LED must be forward biased to some suitable current (usually 5 mA to 20 mA). Modulating signals can then be impressed on this DC bias. A differential amplifier is a good way to accomplish this.

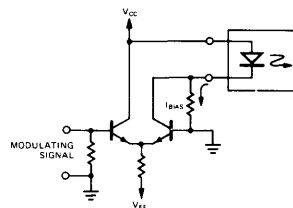

Sensing in linear applications can be done in several ways depending on the requirements. For high frequency performance, the photo-transistor should be operated into a low impedance input current amplifier. The simplest such scheme is a grounded base amplifier.

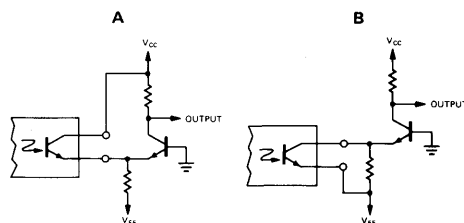

The circuit will work equally well either way, with a phase inversion between the two. Obviously a PNP transistor would work as well.

A feedback amplifier could also be used to get a low impedance input.

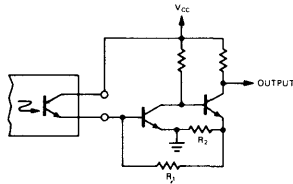

The current gain is $\left(1 + \frac{R_1}{R_2}\right)$.

The input impedance is approximately

$$\left(\frac{R_1}{1 + \frac{V_{CC} - 2V_{BE}}{.026}}\right)$$

For example if $R_1 = 900\Omega$, $R_2 = 100\Omega$, $V_{CC} = 5V$; we would have a current gain of 10 and an input

impedance of about 6.3Ω . This would give a considerable speed improvement over a 100Ω load.

A high speed operational amplifier could be used to give excellent performance.

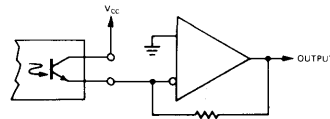

Note that in all cases the output can be taken from either the collector, or the emitter of the photo-transistor depending on the polarity desired. The operating speed is the same in either case.

CONCLUSION

This appnote covers the most commonly used ways of applying photo-transistor opto-isolators. The design engineer will see many ways to expand on these circuits to achieve his end goals. The devices are extremely versatile, and can provide better solutions to many systems problems than other competing components. Special designs are possible to optimize certain parameters such as coupling capacitance, or transfer ratio, and the engineer can expect to see a variety of these products in the future.

SUMMARY OF PROPERTIES OF SIGNAL COUPLING DEVICES

Device	Advantages	Disadvantages
Opto-Isolator	Economical. Solid state reliability. Medium to high speed signal transmission. DC & low frequency transmission. High voltage isolation. High isolation impedance. Small size DIP Package. No contact bounce Low power operation.	Finite ON Resistance. Finite OFF Resistance. Limited ON state current. Limited OFF state voltage. Low transmission efficiency. (Low CTR)
Relays	High power capability. Low ON resistance. DC transmission. High voltage isolation.	High cost. High power consumption. Unreliable. Very slow operation. Physically large.
Pulse Transformers	High speed signal transmission. Moderate size. Good transmission efficiency.	No DC or low frequency transmission. Expensive for high isolation impedance or voltage.
Differential line Drivers and Receivers	Solid state reliability. Small size DIP package. High speed transmission. DC transmission. Low cost.	Very low breakdown Voltage. Low isolation impedance.

MULTIPLEXING LED DISPLAYS

by George Smith

In digital displays, such as would be used in a D.V.M. or counter of conventional design, all digits are operated in parallel, with a separate decoder-driver for each digit operated from data generally stored in a quad latch.

In many cases, a reduction in cost can be effected by operating the display in a time division multiplexed mode. The question of cost effectiveness depends on the particular application. As a general rule, the greater the number of digits in the display, the more advantageous the multiplex system becomes from the cost standpoint. Because of the great variety of situations possible, it is difficult to say at what number of digits the change should be made. In some circumstances, non-multiplexed operation of less than 8 digits is more economical. On the other hand, there are circumstances under which multiplexing is used for three and four digit displays at a cost saving. This application note attempts to show some of the many ways of multiplexing digits, and it is left to the designer to decide whether his own system application would be lower in cost if he used a multiplex scheme.

The properties of light emitting diodes (LED) make

them particularly suitable for multiplexed operation, and hence it is the preferred method to use, if a scheme can be designed which is cost competitive with non-multiplexed operation.

Throughout this paper, it will be generally assumed that we are talking of a system using TTL type logic families, with MSI functions being used where applicable. In most production situations this will be the most economical approach. There will be some cases where discrete gates and flip-flops may yield a lower cost. There are also cases where a single MOS chip contains all the necessary logic functions, and only interface driver circuits are required.

The seven segment numeric displays with a common anode connection made by Litronix provide compatibility with the most widely available decoder-drivers, which are active level low outputs. The commonest devices are SN7447, 8T04, 9317 and similar. Any of these is suitable for driving the Litronix DL-707 type display. For common cathode displays such as the Litronix DL-34M, SN7448, 8T06 and 9307 decoders can be used, and anode drivers become cathode drivers.

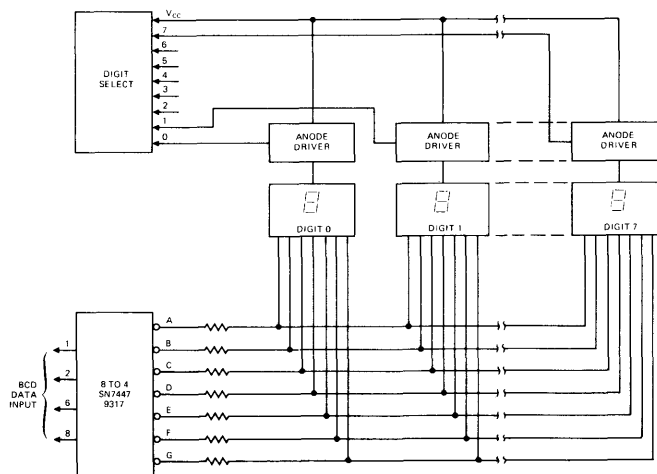

Figure 1

In a multiplex system, the corresponding cathodes of each digit are bussed together, and driven from one seven segment decoder-driver, via the usual current limiting resistors. The display data is presented serially by digit, to the decoder-driver, together with an enable signal to the appropriate digit anode Figure 1.

Each digit anode is driven by a switch, capable of passing the full current of all segments. The simplest switch would be a PNP high current switch or amplifier transistor, such as a core driver type.

In operation, the anode switches are activated one at a time, in the desired sequence, while the appropriate digital data is presented at the input to the decoder-driver. The amount of circuitry required in Figure 1

most of the packages are lower cost than the seven segment decoder. The scheme shown is a 20% cost reduction over non-multiplexed operation, based on O.E.M. prices for the components. For less than eight digits, it would be difficult to compete with non-multiplexed operation using this scheme.

CASE 2:

Multiplexing becomes more attractive, when the data is stored in a shift register, rather than in latches. In this case the data is circulated around the register, at some suitable rate, and is sequentially presented at the input of the seven-segment decoder-driver. The anode drive can be obtained from a counter and decoder as in Figure 2, or from a parallel output shift register — Figure 3.

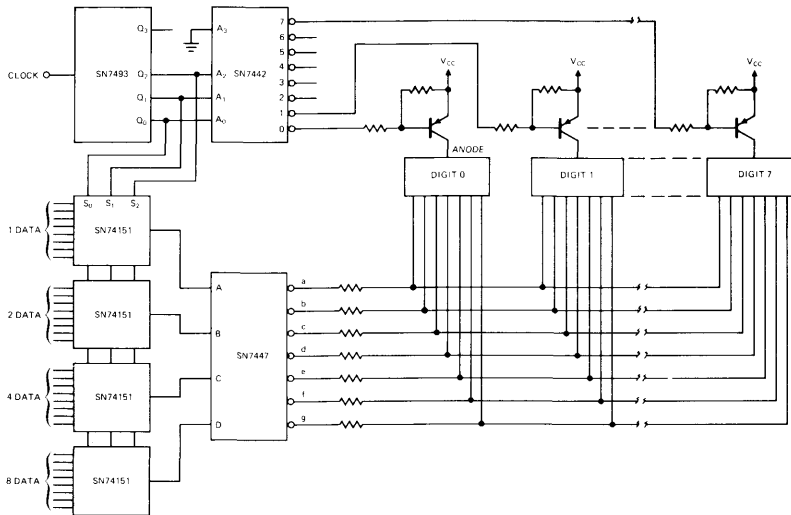

Figure 2

is much less than that used in the non-multiplexed scheme. The question of overall economy is dependent on the amount of circuitry required to sequence the anodes and present the data at the decoder input. Let us consider some typical situations.

CASE 1:

An 8-digit counter-timer display, with the data stored in multiple latch circuits. This is the most common situation present in a counter-timer of conventional design. A quad latch (SN7475) is used to store each digit, and this data is periodically updated. To scan this data, a 4 pole 8 position switch is required (SN74151). To select the appropriate digit, an octal counter (SN7493) and a 1 of 8 decoder (SN7442) are required. The complete circuit is as in Figure 2.

The total package count is about the same for this arrangement, as for non-multiplexed operation, but

This circuit, which can be expanded to any number of digits, circulates a single zero, and thus can directly drive the PNP anode switches. Systems using circulating memories generally require this digit timing circuitry for other reasons, so it is generally available in the system already.

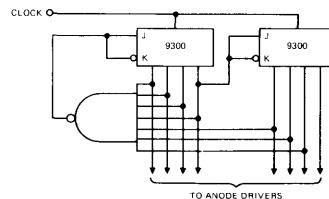

Figure 3

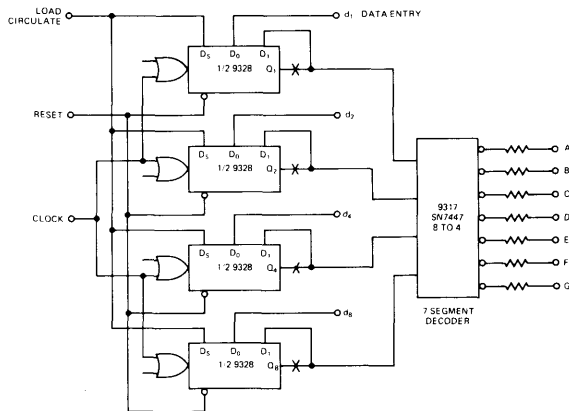

Figure 4

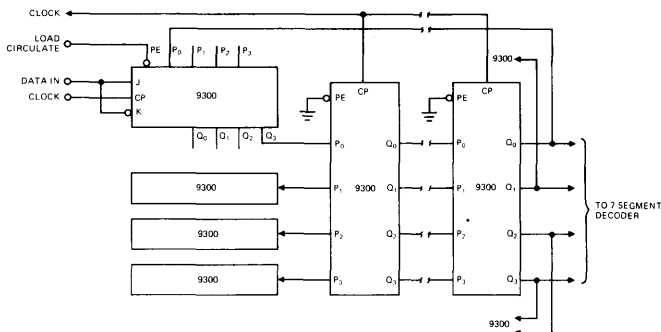

Figure 5

For displays of 8 digits; a very common number in counter-timer instruments, the 9328 dual 8 bit shift register makes a very good circulating shift register. Two packages are required to store and circulate 8 digits — Figure 4.

The scheme can be extended to more digits by adding a 4 bit parallel shift register such as the 9300, for each extra digit; the extra shift bits are inserted at the points marked X in Figure 4. The same circuit can be used for less than 8 digits, if a 12-1/2% duty cycle is satisfactory. For less than 8 digits, where maximum available duty cycle must be maintained, the scheme shown in Figure 5 can be used.

The preceding schemes demonstrate that systems containing recirculating data are very effectively coupled to multiplexed LED displays. Many multi-digit systems such as calculating machines use L.S.I. MOS circuits to provide their logic, and these naturally lend themselves to recirculating data. It is now practical to use custom L.S.I. to provide the logic functions of a D.V.M. or a counter-timer type of instrument, employing multiplexed LED displays, at a significant

cost savings over conventional instrument designs.

Apart from the strictly logical problems involved in a multiplexed display, the designer must choose suitable operating conditions for the LED's. Peak forward current, current pulse width, duty cycle and repetition rate, are all factors which the designer must determine.

The luminous intensity, or the luminance of GaAsP LED's, is essentially proportional to forward current over a wide range, but certain phenomena modify this condition. At low currents, the presence of non-radiative recombination processes, results in less light output than the linear relationship would predict. This effect is noticeable in the region below about 5 mA per segment (for 1/4 inch characters). The result is that noticeable difference in luminance from segment to segment can occur at low currents. At high currents, the power dissipation in the chip causes substantial temperature rise, and this reduces the efficiency of the chip. As a result the light output versus forward current curve falls below the straight

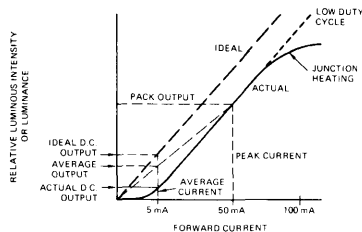

Figure 6

line, at high currents (Figure 6). It should be emphasized that this latter effect is entirely due to self heating. If the power dissipation is limited, by running short pulses at low duty cycle, the output follows the straight line up to very high current densities. Whereas 100 A/cm^2 may be used in DC operation, as much as 10^4 A/cm^2 can be used under pulsed conditions, with a proportionate increase in peak intensity. (If this did not occur, GaAsP lasers could not be built.) Gallium Phosphide, however, has an inherent saturation mechanism that causes a drastic reduction in efficiency at high current densities even if the junction temperature remains constant. This effect is due to competing non-radiative recombination mechanisms at high current density.

As a first approximation the brightness of a pulsed LED will be similar to that when operated at a DC forward current equal to the average pulsed current. For example, for 40 mA peak current at 25% duty cycle, the brightness will be similar to DC operation at 10 mA. The actual brightness comparison will depend on the actual pulsing conditions. Under most legitimate conditions the brightness will be greater for pulsed operation.

Figure 6 shows how the actual light output at 5 mA DC is substantially less than expected from the ideal curve, because of the "foot" on the curve at low currents. Operation at 50 mA peak current and 10% duty cycle yields a high peak output as shown, and an integrated average output that is much closer to the ideal value. It should be obvious that variations in the "foot" from segment to segment cause a significant

variation in light output at a low DC current, but a much smaller variation in the average output when operated in a pulsed mode. As well as an increase in luminance, or luminous intensity due to pulsing, there is an increase in brightness because of the behavior of the eye. The eye does not behave as an integrating photometer, but as a partially integrating and partially peak reading photometer. As a result, the eye perceives a brightness that is somewhere between the peak and the average brightness.

The net result is that a low duty cycle high intensity pulse of light looks brighter than a DC signal equal to the average of the pulsed signal. The practical benefit of multiplexed operation then, is an improvement in display visibility for a given average power consumption besides the lower cost. The brightness variation from segment to segment and digit to digit is also reduced by time-sharing. The gain in brightness over DC operation can be as much as a factor of 5 at low duty cycles of 1 or 2 percent, and peak currents of 50 to 100 mA.

A number of factors must be taken into account when deciding on the design of a multiplexed display. Besides the optical output, thermal considerations are very important.

Most $1/4''$ size LED numerics are rated at 30 mA DC max per segment. Under pulsed operation, higher currents can be used provided several thermal considerations are taken into account.

- (1) The average power dissipation must not exceed the maximum rated power.
- (2) The power pulse width must be short enough to prevent the junction from overheating during the pulse. This implies that the pulse width must get shorter as the amplitude increases.

Present experience indicates that for pulses of $10 \mu\text{s}$, the amplitude should be limited to 100 mA max. Shorter pulses of higher amplitude may be used but the circuit problems become severe if the pulse width is very short. As more information on thermal parameters of the devices becomes available, more specific design rules can be given to assist the designer.

DRIVING HIGH-LEVEL LOADS WITH ISO-LIT™ OPTO-ISOLATORS

by David M. Barton

Frequently a load to be driven by an Iso-Lit requires more current, voltage, or both, than an Iso-Lit can provide at its output.

Available Iso-Lit output current, of course, is found by multiplying input (LED section) current by the "CTR" or current - transfer-ratio. For worst-case design, the minimum specified value would be used. The minimum CTR of the Litronix Iso-Lit 1, 12 and 16 are 0.2, 0.02 and 0.06 respectively. Temperature derating is not usually necessary over the 0 to +60 degree Celcius range because the LED light output and transistor beta have approximately compensating coefficients.

Multiplying the minimum CTR by 0.9 would ensure a safe design over this temperature range. Over a wide range, more margin would be required.

The LED source current is limited by its rated power dissipation. Table I shows maximum allowable I_F vs maximum ambient temperature.

Values for Table I are based on a 1.33 mW/°C derate from the 100 mW at 25°C power rating.

Table I

MAXIMUM TEMPERATURE	I_F MAXIMUM
40°C	65 mA
60°C	48 mA
80°C	25 mA

Obviously, one can increase the available output current then by either choosing a higher CTR-rated Iso-Lit, by providing more current, or both. Table II

Table II

ISO-LIT	$I_{CE(MIN)}$ mA
1	8.6
12	0.86
16	2.5

shows the minimum available output current of each device assuming 60°C derating (from Table I) and a 10 percent margin for temperature effects.

If the Iso-Lit is being operated from logic with 5 volt V_{CC} , and 0.2 volt V_{CE} saturation is assumed for the driving transistor, a 75 ohm R_{IF} resistor will provide the 48 mA. The forward voltage of the IR-emitting LED is about 1.2 volts. Figures 1A and 1B show two such drive circuits.

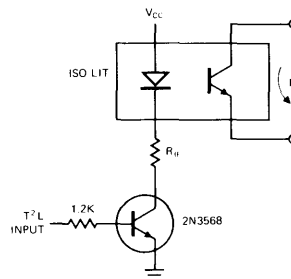

Figure 1A. NPN Driver

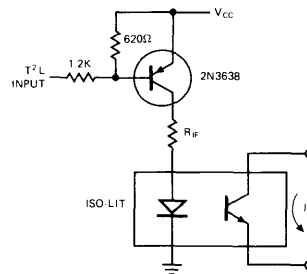

Figure 1B. PNP Driver

A "buffer-gate," such as the SN7440 or Signetics 8855, provides a very good alternative to discrete transistor drivers. Figure 2 shows how this is done. Note that the gate is used in the "current-sinking" rather than the "current-sourcing" mode. In other words, conventional current flows *into* the buffer-gate to turn on the LED. This makes use of the fact that a T²L gate will sink more current than it will source. The SN7440 is specified to drive thirty 1.6 mA loads or 48 mA. Changing R_{IF} from 75 to 68 ohms adjusts for the higher saturation voltage of the monolithic device.

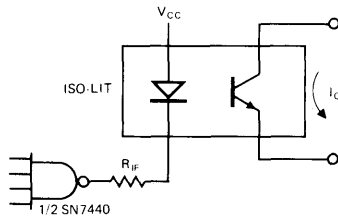

Figure 2. Buffer-Gate Drive

MORE CURRENT

For load currents greater than 8.6 mA, a current amplifier is required. Figures 3A and 3B show two simple one-transistor current amplifier circuits.

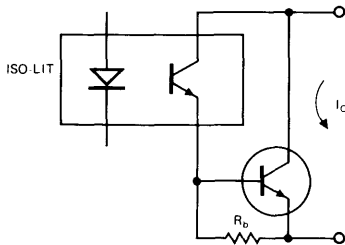

Figure 3A. NPN Current Booster

Since the transistor in the Iso-Lit is treated as a two-terminal device, no operational difference exists between the NPN and the PNP circuits. R_b provides a return path for I_{CBO} of the output transistor. Its value is: $R_b = 400 \text{ mV}/I_{CBO}(T)$ where I_{CBO}(T) is found for the highest junction temperature expected.

Assume that leakage currents double every ten degrees. Use the maximum dissipated power, the specified maximum junction-to-ambient thermal resistance,

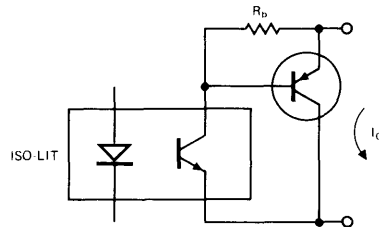

Figure 3B. PNP Current Booster

and the maximum design ambient temperature in conjunction with the specified maximum 25 degree I_{CBO} to calculate I_{CBO}(T).

As an example, suppose a 2N3568 is used to provide a 100 mA load current. Also assume a maximum steady-state transistor power dissipation of 100 mW and a 60°C maximum ambient. The transistor junction-to-ambient thermal resistance is 333°C/watt, so a maximum junction temperature of 60 + 33 or 93°C is expected. This is about 7 decades above 25°C. Therefore, $I_{CBO}(T) = I_{CBO}(\text{max}) \times 27 = 50 \text{ nA} \times 128 = 6.5 \mu\text{A}$. A safe value for R_b is 400 mV/6.5 μA = 62 kilohms.

Working backwards, maximum base current under load will be $I_b/h_{FE}(\text{min}) = 100 \text{ mA}/100 = 1 \text{ mA}$. Current in R_b is $V_{BE}/R_b = 600 \text{ mV}/60\text{k} = 10 \mu\text{A}$, which is negligible. Table II shows that an Iso-Lit 16 could provide more than enough base current for the transistor but an Iso-Lit 12 could not. Less than the maximum allowable drive could be provided to the Iso-Lit 16, since only 1 mA is required. A 20 mA drive provided by a 180 ohm resistor would suffice. An Iso-Lit 1 with 9 mA drive would also work.

If the load requires more current than can be obtained with the highest beta transistor available, then more than one transistor must be used in cascade. For example, suppose 3 amperes load current and 10 watt dissipation are needed. A Motorola MJE3055 might be used for the output transistor, driven by a MJE205 as shown in Figure 4. Using a 5°/watt heat sink and the rated MJE3055 junction-to-case thermal resistance of 1.4°/watt, we find that junction temperature rise is 6.4 × 10, or 64°. Therefore maximum junction temperature is 124°C. This is 10 decades above 25°C making $I_{CBO}(T) = 2^{10} I_{CBO}(\text{max}) = 10^3 I_{CBO}(\text{max})$.

I_{CBO}(max) at 30 volts or less is not given, but I_{CEO} is. Using (for safety) a value of 20 for the minimum low-current h_{FE} of the device, I_{CBO} could be as large as

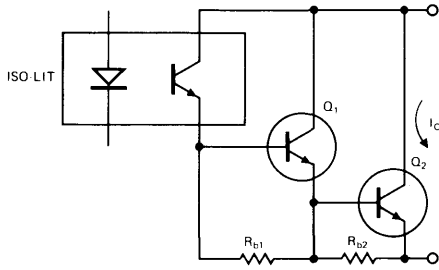

Figure 4. Two-NPN Current Booster

$I_{CE0}/20 = 35 \mu\text{A}$. Then $I_{CB0}(T)$ is 35 mA and $R_{b2} = 400 \text{ mV}/35 \text{ mA} = 11 \text{ ohms}$. For I_b use $I_o/h_{FE}(\text{min @ } 4\text{A}) = 3\text{A}/20 = 150 \text{ mA}$. $I_{Rb2} = 600 \text{ mV}/10 \text{ ohms} = 60 \text{ mA}$, so $I_{e(Q1)} = 210 \text{ mA}$.

Maximum Power in Q_1 will be about 1/14 the power in Q_2 since its current is lower by that ratio and the two collector-to-emitter voltages are nearly the same. This means Q_1 must dissipate 700 mW.

Assuming a small "flag" heat sink having $50^\circ/\text{watt}$ thermal resistance, we find the junction at about 95°C . The 150°C case temperature I_{CB0} rating for this device is 2 mA, so one can work backwards and assume about 1/30 of this value, or $70 \mu\text{A}$. On the other hand, the 25° rated I_{CB0} is $100 \mu\text{A}$. Choosing the larger of these contradictory specifications, $R_{b1} = 400 \text{ mV}/0.1 \text{ mA} = 4\text{k} \approx 3.9\text{k}$. Q_1 base current is $I_{E(Q1)}/h_{FE(Q1-\text{min})} = 210 \text{ mA}/50^* = 4.2 \text{ mA}$. Total current is $I_{b(Q1)} + I_{Rb1} = 4.2 + 0.24 = 4.5 \text{ mA}$. Table II shows that an Iso-Lit 1 could be used here.

MORE LOAD VOLTAGES

All of the current-gain circuits shown so far have one common feature: load voltage is limited by the 30 volt rating of the Iso-Lit, not by the voltage or power rating of the transistor(s). Figure 5A shows a method of overcoming this limitation. This circuit will stand off BV_{CE0} of Q_1 . The voltage rating of the phototransistor is irrelevant since its maximum collector-emitter voltage is the base-emitter voltage of Q_1 (about 0.7 volts).

Unlike the "Darlington" configurations shown previously, this circuit operates "normally-ON." When

no current flows in the LED the phototransistor, being OFF, allows R_2 current to flow into the base of Q_1 , turning Q_1 ON. When the Iso-Lit is energized, its phototransistor "shorts out" the R_2 current turning Q_1 OFF.

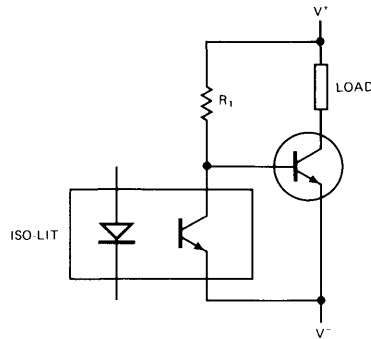

Figure 5A. NPN HV Booster

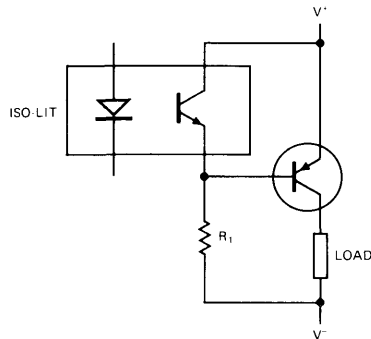

Figure 5B. PNP HV Booster

The value of R_1 depends only on the load-supply voltage $V^+ - V^-$, and the *maximum* required Q_1 base current. This is derived from the minimum beta of Q_1 at minimum temperature and the load current. The required current-drive capability is the same as I_{R1} , since I_{R1} changes negligibly when the circuit goes between its "ON" and "OFF" states.

In some applications either more current gain will be required than one transistor can provide or the power dissipated in R_1 will be objectionable. In these cases, simply use the Darlington high-voltage booster shown in Figure 6A.

*Minimum h_{FE} is obtained using the specification at $I_{CE} = 2\text{A}$ and the "Normalized DC Current Gain" graph given in the Motorola "Semiconductor Data Book," 5th Edition, pp. 7 - 232, 3.

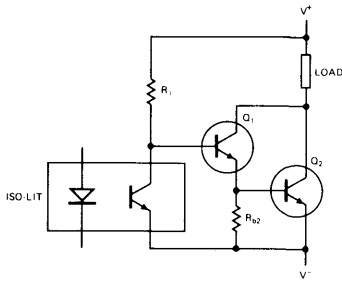

Figure 6A. NPN Darlington HV Booster

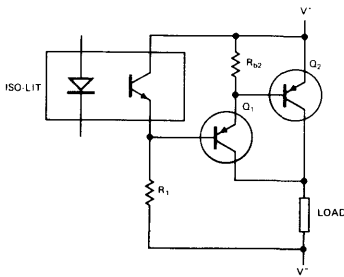

Figure 6B. PNP Darlington HV Booster

If more than one load is being driven and their negative terminals must be in common, use the PNP circuit, Figure 6B. Otherwise, the NPN is better because

the transistors cost less. Of course performance characteristics of the NPN and PNP versions are identical if the device parameters are also the same.

APPLICATIONS

Iso-Lit isolated circuits are useful wherever ground loop problems exist in systems, or where dc voltage level translations are needed. In many systems so-called interpose relays are used between a logic circuit section (which may be a mini-computer) and the devices being controlled. Sometimes *two levels* of interpose relays are used in cascade either because of the load power level or because of extreme difficulties with EMI. Iso-Lits, aided by booster circuits such as those described, can replace many of the relays in these systems.

The reed relays, typically used as the first level of interpose and mounted on the interface logic cards in the electronic part of the system, are almost always replaceable by Iso-Lits since their load is just the coil of a larger relay. This relay may have a coil power of 1/2 to 5 watts and operate on 12, 24 or 48 volts dc.

Assuming worst-case design techniques are carefully followed, system reliability should improve in proportion to the number of relays replaced.

MORE SPEED FROM ISO-LIT™ OPTICAL ISOLATORS

by David M. Barton

Figure 1 shows a typical circuit employing an Iso-Lit to transmit logic signals between electrically isolated parts of a system. In the circuit shown, the Iso-Lit must "sink" the current from one T²L load plus a pull-up resistor. This load is roughly equivalent to a 4 kΩ resistor to V_{CC}. The resistor in series with the LED half of the Iso-Lit must supply the worst-case load current divided by the "current transfer ratio" or CTR of the Iso-Lit. If an Iso-Lit 1 is used, having a min CTR of 0.2, and 30 percent variation in the load is allowed, 8.1 mA is required. This is supplied by the 430Ω resistor.

The maximum repetition rate at which this circuit will operate is only about 3 kHz. The severe speed limitation is due entirely to the characteristics of the photo-transistor half of the Iso-Lit. This device has a large base-collector junction area and a very thick base region in order to make it sensitive to light. C_{ob} is typically 25 pF. This capacitance is, in the circuit of Figure 1, effectively multiplied by a large factor due to the "Miller effect." Also, because the base region volume is large, so is base storage time.

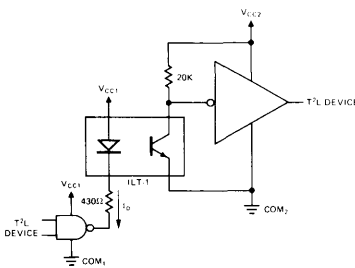

Figure 1

A very simple method of reducing both of these effects is to add a resistor between the base and emitter as shown in Figure 2. This resistor helps by reducing the time constant due to C_{ob} and by removing stored charge from the base region faster than recombination can. When a base-emitter resistor is used, of course, the required LED drive is increased since much of the photo-current generated in the base-collector junction is now deliberately "dumped."

Using this method does not usually result in a large power supply current drain since *average* repetition rate is low in most applications.

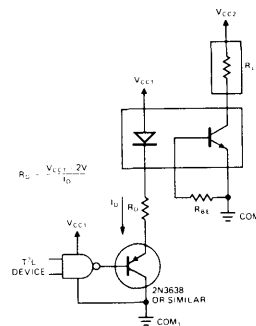

Figure 2

As drive is increased and R_{BE} reduced, turn-on time and turn-off time both decrease. The total amount of charge stored can also be reduced by decreasing the LED drive pulse duration. Also, as higher drive levels are used, the load resistance, R_L can be reduced to further enhance the speed of the circuit. These parameters are related to each other such that all should be changed together for best results.

One important generalization can be made concerning their interdependence. The LED drive pulse duration, T_{in}, output fall time, t_f, output rise time, t_r, and propagation delay, t_p, should occur in a 1.5:1:1:1 ratio, approximately. If this relationship does not occur, the circuit will not operate at as high a repetition rate as it could at the same drive level. T_{out} equals T_{in} at low currents but stretches out at high currents.

Figure 3 is a graph relating the important parameters for a typical Iso-Lit 1 whose CTR is 0.25. The optimum values of T_{in}, R_{BE} and R_L are shown versus LED pulse current as are the resultant output pulse width and maximum full-swing frequency. Rise, fall and propagation time can be read as 2/3 of T_{in}.

Figure 3 shows that increasing drive to 200 mA and using optimum R_{BE} and R_L will increase the maximum repetition rate from 3 kHz to 500 kHz, a 167:1 improvement.

Lower grade isolators will behave similarly if the LED drive level is scaled appropriately to allow for a lower CTR.

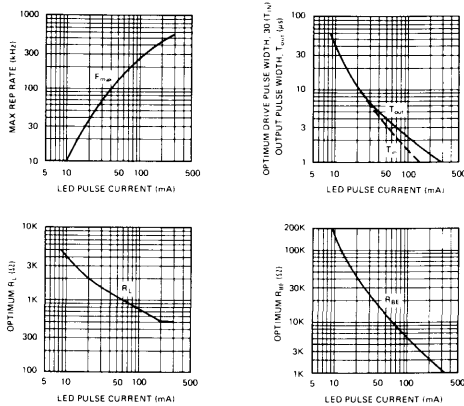

Figure 3. Parameters vs LED Pulse Current

Another method of increasing speed is to operate the photo-transistor as a photo-diode. In this method, bias voltage is supplied between the collector and base terminal, the emitter being unused. Operation to at least 10 MHz is possible this way, but the price is the need for external amplification. Figure 4 is a graph

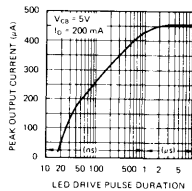

Figure 4. Diode Mode Output Current vs Drive Pulse Duration

showing peak output current versus drive pulse duration for 200 mA peak drive current.

Since output current is small, some type of wide-bandwidth amplifier must be employed in order to drive T²L loads.

One simple solution for intermediate speed operation is the use of a low-power T²L inverter (1/6 74L04). The collector of the photo-transistor is connected to its input along with a 100K pullup resistor. The base is connected to system output-side common. This inverter will in turn drive one 7400 series device.

Another device which will provide a good interface is an integrated comparator amplifier. The photo-transistor collector goes to V_{CC} . Its base has a 200Ω load resistor to ground and goes to one input of the comparator. Also, a resistor R_{oes} goes from this node to the minus supply. This resistor is chosen to supply 50 μA. The other comparator input is grounded. The voltage at the comparator input will switch from -10 mV to +10 mV or more when the diode turns on and the output will drive the T²L loads.

Of course discrete-component amplifiers could be used and may be best in some applications.

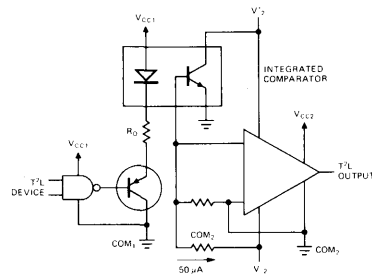

Figure 5

CONCLUSIONS

For operation to 500 kHz, the addition of a base-emitter resistor and a high-current driver is probably the best method of increasing Iso-Lit speed. Above 500 kHz one must revert to photodiode mode and use an external amplifier to drive most loads, particularly T²L.

OPERATING LED'S ON AC POWER

by David M. Barton

Introduction

Frequently it is desirable to operate LEDs on AC power rather than DC. Typically, the power source is 120 VRMS 60 Hz. The most obvious method is to rectify this power with a series diode and use a resistor to limit LED current as shown in Figure 1.

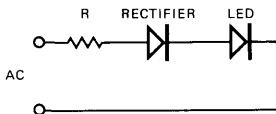

FIGURE 1. The Power Resistor Method

This method, though sound, results in very high power dissipation in the resistor since the LED operates on only 1.6 volts.

The Method

Figure 2 shows a better method. Here a capacitor is used to control LED current and a shunt silicon diode provides rectification.

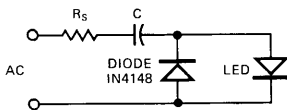

FIGURE 2.

Since, for current in either direction, voltage drop across the LED or rectifier is a negligible part of the supply voltage, current in the capacitor is almost exactly equal to the AC supply voltage divided by the reactance of the capacitor. Average capacitor current is then

1. $I_C (AV) = .9 \times VRMS/X_C$
and average half-cycle LED or rectifier current is
2. $I_{LED (AV)} = 1/2 I_D (AV) = .45 VRMS/X_C$
or, for 120 VRMS, 60 Hz operation,
3. $I_{LED (AV)} = 20 \text{ mA} \times C\mu F$
or $C\mu F = \frac{I_{LED (AV)}}{20 \text{ mA}}$

Figure 3 shows the value of the series capacitor needed for a range of average LED currents assuming 60 Hz, 120 volt power.

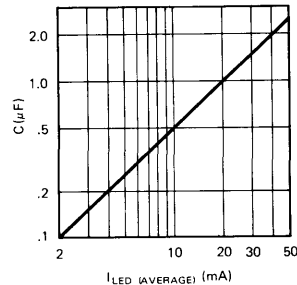

FIGURE 3. Series Capacitor Value vs Average LED Current for 120 VRMS 60 Hz.

A resistor is necessary in series with the capacitor to limit turn-on transient currents. A value of 100 ohms will be adequate in most cases.

The current in the LED, of course, flows almost exactly in quadrature with the line voltage. For this reason, power dissipation is low, being limited to the expected LED and rectifier power loss, the loss in series resistor and to losses in the capacitor. The latter term will be extremely low if high quality capacitors are used. Although power consumption of a circuit may not be of much significance in terms of the cost of the power, it certainly can be important to reduce heat generation within an enclosure.

If more than one LED is to be operated from the same source, simply put the LEDs in series in the same circuit, as shown in Figure 4. For small numbers of LEDs the current will be, for practical purposes, the same as for one.

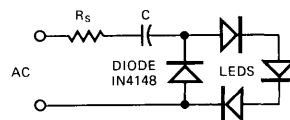

FIGURE 4.

Conclusion

Cost of the series capacitor (mylar) will be similar to the cost of a series power resistor. The shunt diode, a IN4148 or similar, will cost about two cents; much less than a series rectifier which must have a several hundred volt PIV rating.

So, the capacitor method is both lower in cost and lower in heat generation and power consumption than the resistor method.

APPLYING THE DL-1416 Intelligent Display™

by Dave Takagishi

This application note is intended to serve as design and application guide for users of the DL-1416 Alphanumeric Display. The information presented covers: device electrical description and operation, considerations for general circuit designs, multi-digit display systems and interfacing to the 6800, Z80, and 8080 microprocessors.

The DL-1416 was designed to provide an easy-to-use alphanumeric display for the 64 character ASCII systems. Only twelve interconnect pins plus power and ground are needed to drive a single four digit display. The overall package is designed to allow end stacking of the DL-1416 to form any desired character length display.

ELECTRICAL DESCRIPTION

The on-board electronics of the DL-1416 eliminates all the traditional difficulties of using displays—segment decoding, driving, and multiplexing. The DL-1416 has gone further and provided internal memory for the four digits. This approach allows the user to address one of four digits, load the desired data asynchronously to the multiplex rate and continue.

Figure 1 is a block diagram of the circuitry in the DL-1416. The unit consists of a display and a single integrated circuit chip. The display is four 16-segment alphanumeric monolithic LED die magnified to a height of 160 mils. The IC chip contains the 16 segment drivers, 4 digit drivers, 64-character ROM, four-word 7-bit RAM, internal oscillator for multiplexing, multiplex counter/decoder, cursor RAM, write address decoder, and level shifters for the inputs.

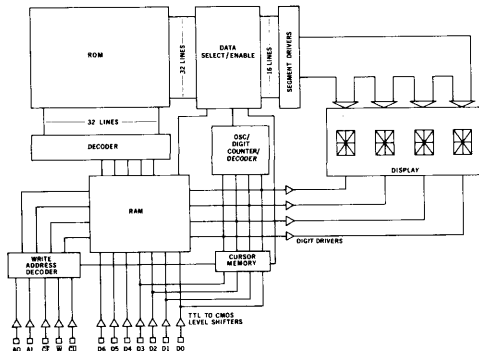

INTERNAL SCHEMATIC
FIGURE 1

The inputs to the DL-1416 are:

- \overline{CE} CHIP ENABLE (active low)
This determines which device in an array will actually execute the loading of data. When the chip enable is in the high state, all inputs are inhibited.
- A₀, A₁ DIGIT ADDRESS
The address to the DL-1416 determines the digit in which the data will be written. Address order is right-to-left for positive-true address.
- D₀ - D₆ DATA LINES
The seven data input lines are designed to accept the 64 ASCII code set. See Table 1 for character set.
- \overline{W} WRITE (active low)
Data to be written into the DL-1416 must be present before the leading edge of write. The data and address must be stable until after the trailing edge.
- \overline{CU} CURSOR (active low)
When the \overline{CU} is held low, the DL-1416 enables the user to write or remove a cursor in any digit position. The cursor function lights all 16 segments in the selected digits without erasing the data. After the cursor is removed, the digit will again display the previously written character.
- V+ POSITIVE SUPPLY
TTL compatible + 5 volts
- V- NEGATIVE SUPPLY
Ground

CHARACTER SET

	D0	D1	D2	D3	D4	D5	D6	D7	D8
L H L L	.	"	0	9	%	&	/		
L H L H	<	>	*	+	,	-	-	/	
L H H L	0	1	2	3	4	5	6	7	
L H H H	8	9	:	:	<	=	>	?	
H L L L	a	A	B	C	D	E	F	G	
H L L H	H	I	J	K	L	M	N	O	
H L H L	P	Q	R	S	T	U	V	W	
H L H H	X	Y	Z	[\]	^	_	

Note: All undefined codes will display a blank.

TABLE 1

OPERATION

Loading data into the DL-1416 is similar to writing into a RAM. The data and address must be present before the leading edge of the write signal (\bar{W}) and must be present until after the trailing edge. The waveforms of Figure 2 demonstrate the relationship of the signals required to generate a write cycle utilizing chip enable (\bar{CE}) and write (\bar{W}) (Check data sheet for minimum values).

As can be seen from the waveforms, \bar{CE} and \bar{W} are interchangeable. The true internal "write" function is formed by the "and-of-the-nots".

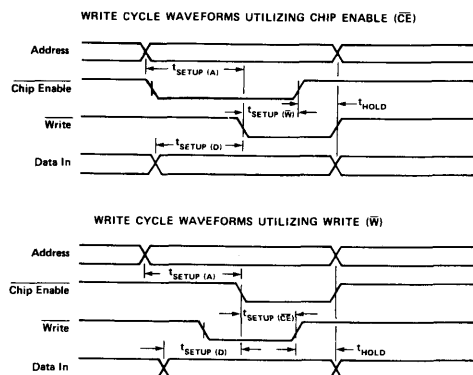

ADDRESS TABLE
FIGURE 2

Multiplexed display systems sequentially read and display data from a memory device. In *synchronous* systems, control circuitry must compare the location of data to be read and displayed to the location of new data to be stored, i.e. synchronize, before a write can be done. This can be slow if there are many memory locations. It can also be cumbersome.

Data entry of the DL-1416 is *asynchronous* and data may be stored in random order. Each digit will continue to display the character last "written" until replaced by another.

The cursor function causes all 16 segments of a digit to light. The cursor can indicate the position in the display of the next character to be entered. The cursor *is not* a character but overrides display of the stored character. Upon removal of the cursor, the display will again show the character stored in memory.

The cursor can be written into any digit position by enabling chip enable (\bar{CE}), cursor (\bar{CU}), the positional data, and a write (\bar{W}) signal. The position of the cursor will be dependent on which of the first four data lines (D_0 , D_1 , D_2 , D_3) are held high. A high on data line D_0 will place a cursor display in the right-most digit and respectively a high on data

line D_3 will place a cursor display in the left-most digit. The cursor can be loaded into, or erased from more than one position simultaneously by simply holding more than one data line high during the cursor write cycle.

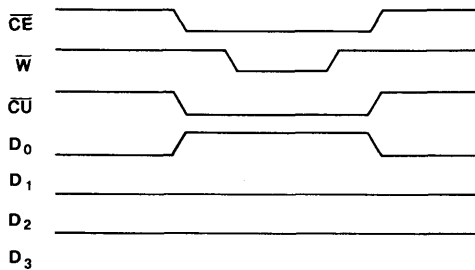

CURSOR WRITE CYCLE
FIGURE 3

The cursor will remain displayed after the cursor (\bar{CU}) and write (\bar{W}) signals have been removed. The wave forms in Figure 3 show a cursor being placed in Digit 0 and erased from Digit 1, Digit 2, and Digit 3 simultaneously.

Hardwiring the cursor (\bar{CU}) line high is not recommended. This internal cursor memory will be randomly loaded on power-up and all positions must be cleared before a cursor-free display is ensured.

GENERAL CIRCUIT DESIGN CONSIDERATIONS

Using positive-true address logic, address order is from right to left. For left to right address order, use the "ones-complement" or simple inversion of the addresses.

For systems with only a 6 bit ASCII code format, data line D_6 cannot be left open. Data D_6 must be the complement of data line D_5 . If an illegal code is loaded into the DL-1416, it will display a blank in the digit accessed.

A "display test" function can be realized by simply storing a cursor in all digits simultaneously. This is done by holding D_0 , D_1 , D_2 and D_3 high and \bar{CU} low during a cursor write cycle. The same operation, with the data lines low will end "display test".

Because of the random state of the cursor RAM after power up, it is necessary to clear it initially to assure that all the cursors are off.

When using DL-1416's on a separate display board having more than two feet of cable length, it may be necessary to buffer all DL-1416 inputs. This is most easily achieved with hex-non-inverting buffers such as 74365 IC's. The object is to prevent transient current in the DL-1416 protection diodes. The buffers should be located on the display board near the DL-1416's. Local power supply bypass capacitors are also needed in many cases. These should be 6 or 10 volt tantalum type having $10\mu\text{F}$ or greater capacitance. Low internal resistance is important to eliminate voltage transients due to the current steps which result from the internal multiplexing of the DL-1416.

If small wire cables are used, it is good engineering practice to calculate the wire resistance of the ground plus the +5 volt wires. More than 0.1 volt drop (at 25mA per digit worst case) should be avoided, since this loss is in addition to any inaccuracies or load regulation limitations of the power supply. limitations of the power supply.

GENERAL INTERFACE

The most general and straight-forward interface approach would be to use the parallel I/O device of a microprocessor. This interface scheme can be completely software dependent. One eight bit output port can handle the seven input data bits and the cursor. Another eight bit output port can contain the address and chip enable information with one bit reserved for the write signal.

An 8080 system shown in Figure 4 illustrates a 16 character display using a 8255 programmable peripheral interface I/O device with a 7442 one-of-ten decoder added for ease of programming. The following program will display a simple 16 character message using the parallel I/O interface.

INIT:	MVI A, 80H;	control data mode 0
	OUT CONTROL;	load control register
CUSR:	MVI A, 00H;	clear cursor data
	OUT PORTA;	load data port
	MVI B, 0FH;	set counter
CUSR1:	MOV A, B	
	CALL DSPWT;	write subroutine
	DCR B;	decrement counter
	JNZ CUSR1;	16 characters
DISP:	LXI H, TABLE;	set table
DISP1:	MOV A, M	
	OUT PORTA;	load data output
	MOV A, B	
	CALL DSPWT;	load address & write
	INX H;	increment table address
	INR B;	increment counter
	MVI A, 10H;	set # of digits
	CMP B	
	JNZ DISP1;	16 characters
	HLT;	end of program
DSPWT:	ORI 80H;	set write bit off
	OUT PORTB;	load address
	ANI 7FH;	set write bit on
	OUT PORTB;	load write
	ORI 80H;	set write bit off
	OUT PORTB;	load write
	RET	
TABLE:	DB	0C3H
	DB	0C9H
	DB	0D4H
	DB	0D3H
	DB	0C1H
	DB	0D4H
	DB	0CEH
	DB	0C1H
	DB	0C6H
	DB	0A0H
	DB	0D3H
	DB	0D4H
	DB	0C8H
	DB	0C7H
	DB	0C9H
	DB	0CCH

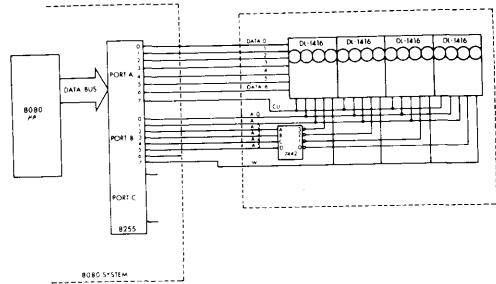

FIGURE 4

I/O OR MEMORY MAPPED ADDRESSING

Some designers may wish to avoid the additional cost of a parallel I/O device in their system. Structuring the addressing architecture for the DL-1416 to look like a set of output devices (I/O mapped) or RAM's, ROM's (memory mapped) is ideal. However, the set-up and hold times of the DL-1416 are too slow for some present μP 's running at maximum speed.

To operate at maximum clock rates, the processor must be made to pause for the required display write cycle interval.

DL 1416/8080 INTERFACE

Microprocessors like the 8080 and Z80 have the ability to generate "wait states" for use with relatively slow memories. Figure 5 shows a circuit which utilizes "wait states" to interface the DL-1416 display to an 8080 system with a T cycle = 500 nS.

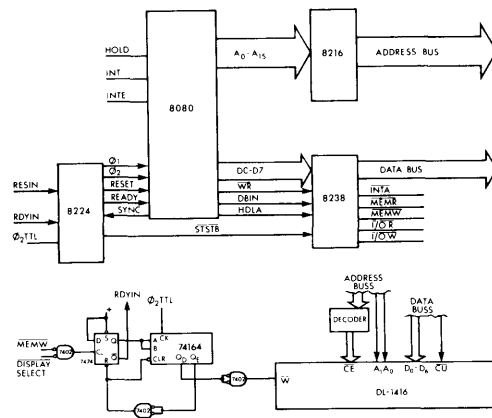

FIGURE 5

The signal $\overline{\text{MEMW}} \bullet \text{DISPLAY SELECT}$ defines a DL-1416 display write cycle and initiates the RDYIN signal. $\overline{\text{MEMW}}$ alone would generate wait states for all write cycles and would slow down total computation. The shift register, 74164, is useful for generating a DL-1416 write signal which meets the setup times for different processor clock rates. The timing diagram, Figure 6, illustrates the relationship between write, wait, and DL-1416 write.

*Note: System controller 8238 required for an early $\overline{\text{MEMW}}$ signal.

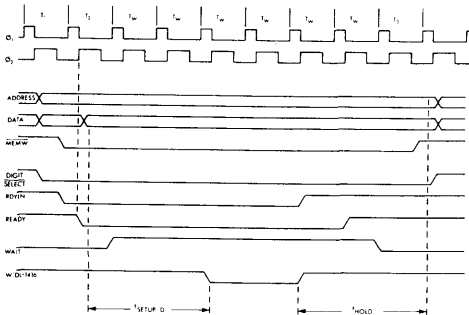

FIGURE 6

DL-1416/Z80 INTERFACE

The organization of the Z80 is very similar to the 8080 processor. Both processors utilize wait states for slow memory and, as can be seen in Figure 7, the interface can be identical to the 8080 System. For T cycle = 500 nS, only signal names are different.

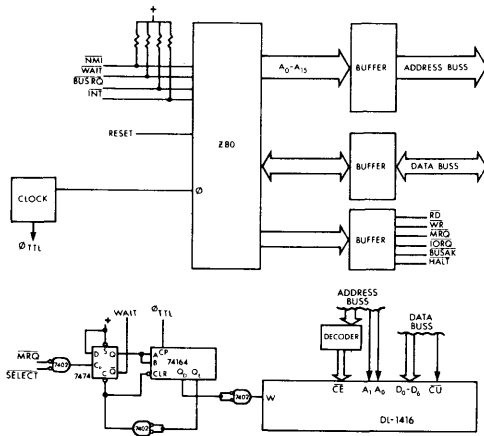

FIGURE 7

DL-1416/6800 Interface

For processors such as the 6800 that do not have wait state capability, clock pulse stretching techniques can be used. Microprocessor clocks such as the Motorola MC6871B have the ability to hold either $\overline{\text{O1}}$ or $\overline{\text{O2}}$. Figure 8 uses the same interface techniques as for the 8080 and Z80. The signal $\overline{\text{H2}}$ extends the $\overline{\text{O2}}$ clock. All address and data lines will remain valid until $\overline{\text{H2}}$ is released. $\overline{\text{H2}}$ was taken from the output of the first stage of the shift register in this case to synchronize with $\overline{\text{O2}}$; otherwise a narrow $\overline{\text{O1}}$ may result.

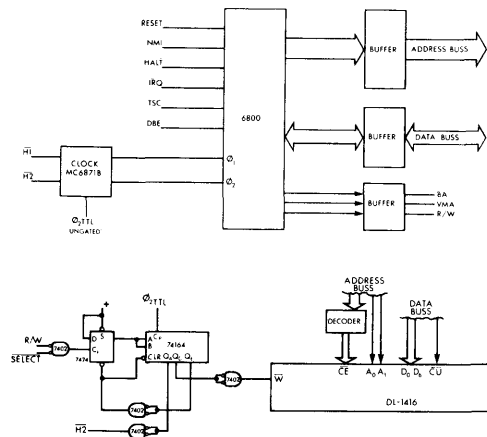

FIGURE 8

CONCLUSION

The interface schemes shown demonstrate the general simplicity of DL-1416 use with microprocessors. The differences among the examples are in providing proper write signals. Because of the setup and hold times of the DL-1416, many microprocessor systems will require some type of interface circuitry for compatibility. The techniques used in these examples were chosen for their versatility in accepting a wide range of clock rates. The user will undoubtedly invent other schemes to optimize his particular system to its requirements.

This application note is not intended to imply specific endorsement or warranty of other manufacturer's products by Litronix.

MOUNTING CONSIDERATIONS FOR LED LAMPS AND DISPLAYS

by Dave Takagishi

There are numerous ways to mount an LED lamp into a panel or a piece of equipment and this application note is written as an aid to designers and engineers when using LED lamps and displays.

MOUNTING TECHNIQUES:

There are several ways to mount LED lamps such as the Litronix RL2000 by soldering directly into PCB's, plugging into sockets, or panel mounting with or without clips. Bending of the leads is allowed bearing the following guidelines in mind. Leads must not be bent closer than 0.65 inches from the base of case when leads are not in excess of .020 inch in diameter. Leads should be clamped next to the case during bending of leads to relieve stresses. Under no circumstances must any mechanical force be applied to case while bending the leads. Also, incorrectly spaced holes in the printed circuit board will place mechanical stress on the plastic case which can cause failure during soldering.

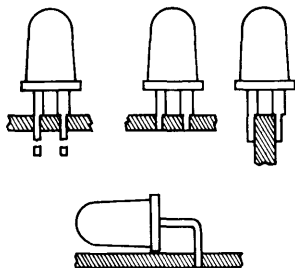

Displays of the DL747 or DL707 type can be soldered directly into a printed circuit board or be plugged into sockets. Stick display products such as the DL4530 can be plugged into a connector or soldered to a cable directly. Stick products can also be provided with pins suitable for soldering or special clip-on pins can be flow soldered directly to the board such as from Precision Concepts. Many displays

can be end-stacked (butted end-to-end) to obtain longer displays with more digits. This usually causes no break in digit spacing. In applications using screw-down mounting, a flexible washer should be used to avoid strain from misalignment or board warpage.

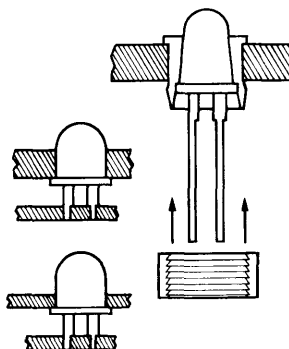

Connector/Socket Suppliers

Aries	Frenchtown, NJ
Augat	Attleboro, MA
Berg	New Cumberland, PA
EMC	Woonsocket, RI
Robinson Nugent	New Albany, IND
Precision Concept, Inc.	Bohemia, NY

(Partial List)

THERMAL CONSIDERATIONS:

Most LED failures can be traced to excess thermal stress. A typical LED chip is mounted on a substrate or lead frame with a wire bond from the top of the chip to a metallized trace on the substrate and is encapsulated in epoxy. Temperature changes cause these various materials to expand and contract at different rates. Extreme low temperatures are most likely to cause structural failure. High temperatures, usually cause reduced lifetime rather than immediate failures.

The internal LED junction temperature depends on ambient temperature, power applied to the LED, and the thermal resistance, LED chip-to-ambient.

Long-term degradation of the LED chips, causing reduced light output, will occur if junction temperature exceeds 125 deg. C. Also the epoxy material overcoating the LED chips may gradually become opaque if it is subjected to temperatures above 125 deg. C.

For these reasons, all Litronix LED products carry derating specifications designed to limit LED junction temperature to 100 deg. C.

Particular care is needed in designing multiplexed systems. Here, increased forward voltage and the effects of the thermal time constant, chip to ambient (about 10mS typical) can cause "thermal ripple" peak excursions above 100 deg. C while calculated average temperature is much lower.

A separate reason for keeping LED chip temperature down is the reduced light output, shown in Figure 1. One can reach a point of diminishing returns, particularly in multiplexed systems, in which an increase in current reduces reliability while actually resulting in little or no increase in display visibility. In such cases, one would be well advised to put his money in higher brightness-grade displays.

A well-designed display system, especially if high power levels or multiplexed operations are involved, should:

1. Allow for convection airflow around the display.
2. Place other heat-generating components* either away from or above, but never below the display (*Display current-control resistors, for example).
3. Take the increased forward voltage and "thermal ripple" peaks into account, in multiplexed systems, and not allow peak temperature to exceed 100 deg. C.

In common with many semiconductor products, LED displays offer the user the most reliable and longest lifetime product available. These good properties do depend, however, on proper usage. Semiconductor products are well-known to be rather unforgiving of abuse when compared to the older technologies. LED's are not different, they are, in fact, hybrid integrated circuits.

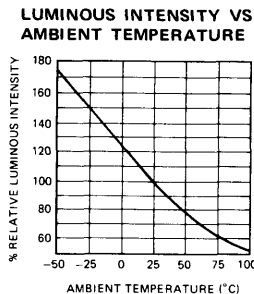

SOLDERING CONSIDERATIONS:

Care should be taken not to overheat LED's when soldering. Effectiveness and safety in soldering are related to three basic parameters: temperature, time, and distance. In general, soldering time should not exceed 3 seconds at 1/16 inch from case at 260°C. Some packages allow greater latitude, as indicated on individual data sheets.

OPTICAL CONSIDERATIONS:

Litronix recommends the use of a contrast enhancing filter in front of LED displays. This filter will increase the contrast ratio of digit to surrounding area and help remove reflected light and glare from the PCB and components around the display. Insetting the display to reduce direct ambient light on the display should also be considered.

Litronix displays have been designed to maximize contrast ratio. Displays such as the DL747 series have a black matte plastic cap surrounding the segments. Some multi-digit displays have a red cap to enhance the contrast. Other displays with clear caps will require a filter.

ROHM & HAAS red "Plexiglass" #2423 makes a good general purpose filter for the 640-660 nm Peak Emission Wavelength of red LEDs. A 1/16 inch thick sheet of this inexpensive material is quite effective. Additional information on this and other filter materials may be obtained by contacting the following suppliers:

ROHM & HAAS	Philadelphia, PA
HOMALITE	Wilmington, DEL
PANELGRAPHIC	West Caldwell, NJ
3M	St. Paul, MIN
POLAROID	Cambridge, MASS

FOR RED LEDS

ROHM & HAAS	Plexiglass 2423
HOMALITE	1670, 1605
PANELGRAPHIC	Red 60, Red 63,
	Red 65, Purple 90
POLAROID	HRCP

FOR GREEN LEDS

ROHM & HAAS	Plexiglas 38168
PANELGRAPHIC	Green 48
HOMALITE	1425, 1440

FOR YELLOW LEDS

PANELGRAPHICS	Yellow 25, Amber 23
HOMALITE	1720, 1726

NEUTRAL DENSITY FILTER

HOMALITE	Neutral Gray 10
----------	-----------------

DISPLAYING MESSAGE SYSTEMS WITHOUT A MICROPROCESSOR

by Dave Takagishi

The DL-1416, 4 digit 16 segment, alphanumeric "Intelligent" display, and succeeding products in the family, have on board memory, decoder and drive circuitry. This makes it particularly well suited to marry directly to a microprocessor. However, small multi-message systems of 4, 8, 12, 16 character length need not have a microprocessor to drive the Alpha-Numeric Display. The DL-1416 with the aid of PROM can combine lighted indicators, status displays, annunciator messages or symbols, or a "canned message" into a single display.

ANNUNCIATOR DISPLAYS

An automobile, for example, has several switches each lighting its own status or annunciator indicator. A single DL-1416 Alphanumeric Display could easily display messages alternately upon interrogation of the appropriate switches.

The circuit shown in Figure 1 will display four character messages sequentially for each open switch and continue to display until switches are returned to their normally closed positions. The Counters U4 and U5 address the PROM U6 and select switches on U1. The Data Selector, U1, sequentially selects one of eight switches (oil, temperature, catalytic, generator, brake, door, belt, and null). The eighth switch or null state can display a blank for a normal or off condition. The output of U1 enables the DL-1416, CE. When this signal goes high, the Monostable, U2, will fire and inhibit the Oscillator U3 for approximately a two second display time. The PROM, U6, generates the ASCII code data for each word. Expansion of the display can easily be achieved by adding a PROM for each additional DL-1416.

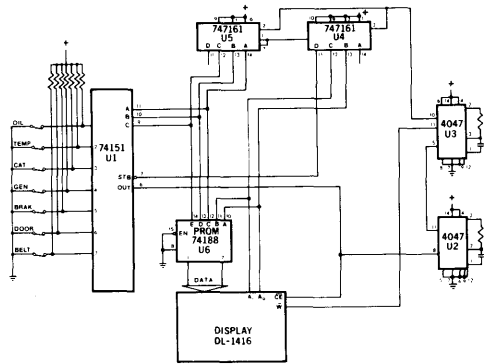

FIGURE 1

Another annunciator type display is shown in Figure 2. This display has a message of up to 16 characters and will continue to display the same line until the 6 bit input code changes state. With this scheme, it can be seen that the 16 character X64 line message PROM can easily be adapted for other message and character length combinations.

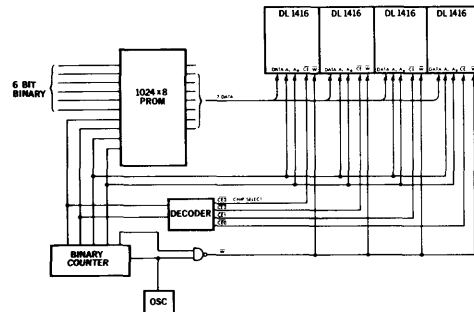

FIGURE 2
TYPICAL CIRCUIT FOR
64 MESSAGES OF 16 CHARACTERS LONG

CANNED MESSAGES

The canned message type display can be an ideal sales, marketing or instructional aid. The message can be altered by replacing the PROM.

The technique for this display would be to sequentially display a word or group of words, depending on the character length of the display, through the entire message. The system could either continue to repeat itself or could go through the complete sequence once each time a switch is operated.

Figure 3 is the schematic for a sales demo box for the DL-1416. A 256X8 PROM was used to display an 8 digit-32 word message. The oscillator, U1, increments the counters U2-U4 providing the address for the DL1416's and PROM U9. After eight counts the monostable U10 is fired, inhibiting the oscillator for a two second display time. Devices U5 and U8 were added for cursor control. Decoder U8 will alternately enable or disable a data bit for a cursor to proceed writing new data into each digit. The multiplexer U5 will select the character data or the cursor data for the D0-D3 data lines. Inverters on the address lines cause data entry to occur from the left rather than from the right.

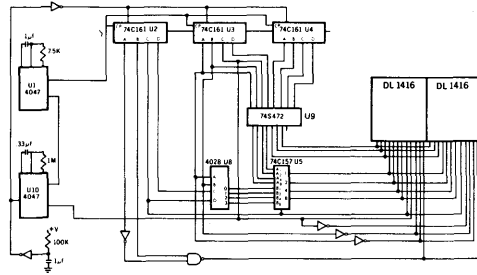

FIGURE 3

Applying the DL-2416 Intelligent Display™

by Dave Takagishi

This application note is intended to serve as a design and application guide for users of the DL-2416 alphanumeric intelligent display. The information presented covers device electrical description and operation, considerations for general circuit design, and interfacing the DL-2416 to microprocessors.

ELECTRICAL & MECHANICAL DESCRIPTION

The internal electronics in the DL-2416 intelligent display eliminates all the traditional difficulties of using multi-digit light emitting displays (segment decoding, drivers, and multiplexing). The intelligent display also provides internal memory for the four digits. This approach allows the user to asynchronously address one of four digits, and load new data without regard to the LED multiplex timing.

Figure 1 is a block diagram of the DL-2416. The unit consists of four 17-segment monolithic LED die and a single CMOS integrated circuit chip. The LED die are magnified to a height of 160 mils by built-in lenses. The IC chip contains 17 segment drivers, four digit drivers, 64 character ROM, four word x 7 bit Random Access Memory, oscillator for multiplexing, multiplex counter/decoder, cursor memory, address decoder, and Miscellaneous Control logic.

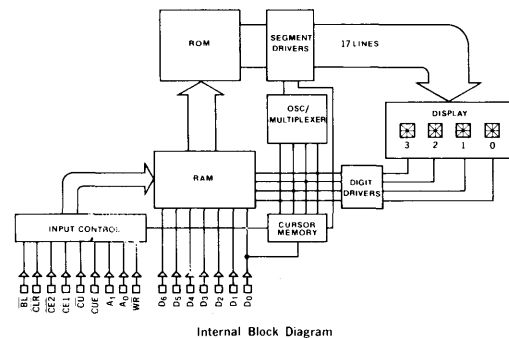

Internal Block Diagram

Figure 1

PACKAGING

Packaging consists of a transfer-molded lexan or nylon lens which also serves as a "encapsulation shell" since it covers five of the six "faces". The assembled and tested substrate (ceramic or "PTF" multilayer), is placed within the shell and the entire assembly is then filled with a water-clear IC-grade epoxy.

This yields a very rugged part, which is quite impervious to moisture, shock and vibration. Although not "hermetic", the device will easily withstand total immersion in water/detergent solutions.

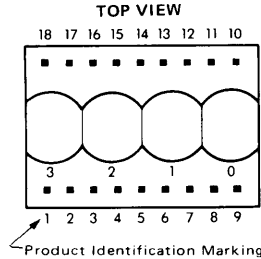

Pin	Function	Pin	Function
1	$\overline{CE1}$ Chip Enable	10	Gnd
2	$\overline{CE2}$ Chip Enable	11	D0 Data Input
3	\overline{CLR} Clear	12	D1 Data Input
4	CUE Cursor Enable	13	D2 Data Input
5	\overline{CU} Cursor Select	14	D3 Data Input
6	\overline{WR} Write	15	D6 Data Input
7	A1 Digit Select	16	D5 Data Input
8	A0 Digit Select	17	D4 Data Input
9	VCC	18	BL Display Blank

Figure 2

ELECTRICAL INPUTS TO THE DL-2416

VCC Positive supply +5 volts

Gnd Ground

D0-D6 Data Lines

The seven data input lines are designed to accept the first 64 ASCII characters. See Figure 3 for character set. (The DL-2416 interprets all undefined codes as a blank).

A0, A1 Address Lines

The address determines the digit position to which the data will be written. Address order is right to left for positive-true logic.

\overline{WR} Write (Active Low)

Data and address to be loaded must be present and stable before and after the trailing edge of write. (See data sheet for timing information).

$\overline{CE1}$, $\overline{CE2}$ Chip Enable (Active Low)

This determines which device in an array will actually accept data. When either or both chip enable is in the high state, all inputs are inhibited.

\overline{CLR} Clear (Active Low)

When held low for 15 mS, the data RAM will be cleared.

CUE Cursor Enable. Activates Cursor function.

Cursor will not be displayed regardless of cursor memory contents when cue is Low. Cursor Select (Active Low)

\overline{CU}

This input must be held high to store data in data memory and low to store data into the cursor memory.

\overline{BL}

Display Blank (Active Low) Blanking the entire display may be accomplished by holding the \overline{BL} input low. This is not a stored function, however. When \overline{BL} is released, the stored characters are again displayed.

0	1	2	3	4	5	6	7	8	9	-	/	*	+	-	.	/
A	B	C	D	E	F	G	H	I	J	K	L	M	N	O		
P	Q	R	S	T	U	V	W	X	Y	Z	[\]	^	_	

Figure 3

CLEAR MEMORY

Clearing of the entire internal four-digit memory may be accomplished by holding the clear line (\overline{CLR}) low for one complete internal display multiplex cycle, 15 mS minimum; less time may leave some data uncleared. \overline{CLR} does not clear the cursor memory.

DISPLAY BLANKING

Blanking the display may be accomplished by loading a blank, space or illegal code into each digit of the display or by using the (\overline{BL}) display blank input. Setting the (\overline{BL}) input low does not affect the contents of either data or cursor memory. A flashing display can be realized by pulsing (\overline{BL}).

OPERATION

Multiplexed display systems sequentially read and display data from a memory device. In synchronous systems, control circuitry must compare the location of data to be read to the location or position of new data to be stored or displayed, i.e., synchronize before a Write can be done. This can be slow and cumbersome.

Data entry in "intelligent displays" is asynchronous and may be done in any random order. Loading data is similar to writing into a RAM. Each digit has its own memory location and will display until replaced by another code.

The waveforms of Figure 4 demonstrate the relationships of the signals required to generate a write cycle.

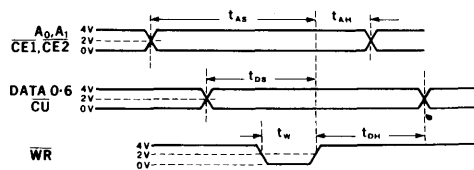

Figure 4

(Check individual data sheet for minimum values). As can be seen from the waveforms, all signals are referenced from the rising or trailing edge of write.

CURSOR

The cursor function causes all 16 line-segments of a digit to light. The cursor can be used to indicate the position in the display of the next character to be entered. The cursor is not a character but overrides the display of a stored character. Upon removal of the cursor, the display will again show the character stored in memory.

The cursor can be written into any digit position by setting the cursor enable (CUE) high, setting the digit address (A_1, A_0), enabling Chip Enable, ($\overline{CE1}, \overline{CE2}$), cursor select (\overline{CU}), Write (\overline{WR}) and Data (D0). A high on data line D0 will place a cursor into the position set by the address A_0 & A_1 . Conversely, a low on D0 will remove the cursor. The cursor will remain displayed after the cursor (\overline{CU}) and write (\overline{WR}) signals have been removed. During the cursor-write sequence, data lines D1 through D6 are ignored by the DL-2416.

If the user does not wish to utilize the cursor function, the cursor enable (CUE) can be tied low to disable the cursor function. A flashing cursor can be realized by simply pulsing the CUE line after cursor data has been stored.

LOADING DATA													DIGIT						
\overline{BL}	$\overline{CE1}$	$\overline{CE2}$	CUE	\overline{CU}	\overline{WR}	\overline{CLR}	A_1	A_0	D6	D5	D4	D3	D2	D1	D0	3	2	1	0
L	X	X	X	H	X	H	X	X	X	X	X	X	X	X	X	BLANK			
H	H	X	L	H	X	H	X	X	X	X	X	X	X	X	X	PREVIOUS CHARACTERS			
H	X	H	L	H	X	H	X	X	X	X	X	X	X	X	X	NC	NC	NC	NC
H	X	H	L	H	X	H	X	X	X	X	X	X	X	X	X	NC	NC	NC	NC
H	L	L	L	H	L	H	L	L	L	L	L	L	L	L	H	NC	NC	NC	A
H	L	L	L	H	L	H	L	L	L	L	L	L	L	L	H	NC	NC	B	A
H	L	L	L	H	L	H	L	L	L	L	L	L	L	L	H	NC	C	B	NC
H	L	L	L	H	L	H	L	L	L	L	L	L	L	L	H	D	C	NC	A
H	L	L	L	H	L	H	L	L	L	L	L	L	L	L	H	D	C	B	E
H	L	L	L	H	L	H	L	L	L	L	L	L	L	L	H	D	X	B	E
H	L	L	L	H	L	H	L	L	L	L	L	L	L	L	H	SEE CHARACTER SET			

LOADING CURSOR													DIGIT						
\overline{BL}	$\overline{CE1}$	$\overline{CE2}$	CUE	\overline{CU}	\overline{WR}	\overline{CLR}	A_1	A_0	D6	D5	D4	D3	D2	D1	D0	3	2	1	0
H	L	L	L	H	X	H	X	X	X	X	X	X	X	X	X	Normal Data Entry			
H	L	L	L	H	X	H	X	X	X	X	X	X	X	X	X	Enable Previous Stored Cursors			
H	L	L	L	H	X	H	X	X	X	X	X	X	X	X	X	NC	NC	NC	NC
H	L	L	L	H	X	H	X	X	X	X	X	X	X	X	X	NC	NC	NC	NC
H	L	L	L	H	X	H	X	X	X	X	X	X	X	X	X	NC	NC	NC	NC
H	L	L	L	H	X	H	X	X	X	X	X	X	X	X	X	NC	NC	NC	NC
H	L	L	L	H	X	H	X	X	X	X	X	X	X	X	X	D	K	B	E
H	L	L	L	H	X	H	X	X	X	X	X	X	X	X	X	D	X	B	E
H	L	L	L	H	X	H	X	X	X	X	X	X	X	X	X	NC	NC	NC	NC

X - Don't care
NC - No change from previously displayed characters

Figure 5

GENERAL DESIGN CONSIDERATIONS

Using Positive true logic, address order is from right to left. For left to right address order, use the "ones complement" or simple inversion of the addresses.

For systems with only a 6-bit (abbreviated ASCII) code format, Data Line D6 cannot be left open. Data D6 must be the complement of Data Line D5.

A "display test" or "lamp test" function can be realized by simply storing a cursor into all digits.

Because of the random state of the cursor RAM after power up, if the cursor function is to be used, it will be necessary to clear cursors initially to assure that all cursor memories contain its zero state.

When using DL-2416's on a separate display board having more than two feet of cable length, it may be necessary to buffer all DL-2416 inputs. This is most easily achieved with Hex non-inverting buffers such as the 74365. The object is to prevent transient current in the DL-2416 protection diodes. The buffers should be located on the display board near the DL-2416's.

Local power supply bypass capacitors are also needed in many cases. These should be 6 or 10 volt, tantalum type having 10 μ F or greater capacitance. Low internal resistance is important due to current steps which result from the internal multiplexing of the DL-2416.

If small wire cables are used, it is good engineering practice to calculate the wire resistance of the ground plus the +5 volt wires. More than 0.1 volt drop, (at 25mA per digit worst cast) should be avoided, since this loss is in addition to any inaccuracies or load regulation limitations of the power supply.

The 5-volt power supply for the DL-2416's should be the same one supplying V_{CC} to all logic devices which drive the display devices. If a separate supply must be used, then local buffers using hex non-inverting gates should be used on all DL-2416 inputs and these buffers should be powered from the display power supply. This precaution is to avoid logic inputs higher than display V_{CC} during power up or line transients.

INTERFACING THE DL-2416

A general and straight-forward interface circuit is shown in Figure 6. This scheme can easily interface to μ P systems or any other systems which can provide the seven data lines, appropriate address and control lines.

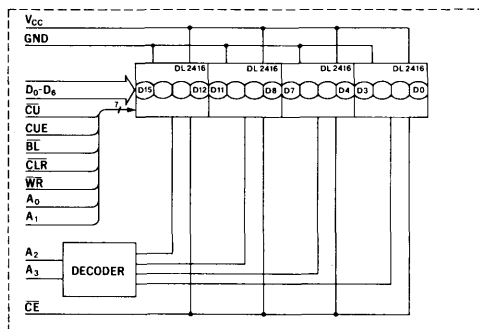

GENERAL INTERFACE CIRCUIT

Figure 6

PARALLEL I/O

The parallel I/O device of a microprocessor can easily be connected to the circuit in Figure 6. One eight bit output port can provide the seven input data bits and the cursor (CU). Another eight bit output port can

contain the address and chip enable information and the other control signals.

Figure 7. illustrates a 16-character display with an 8080 system using the 8255 programmable peripheral interface I/O device. The following program will display a simple 16-character message using this interface.

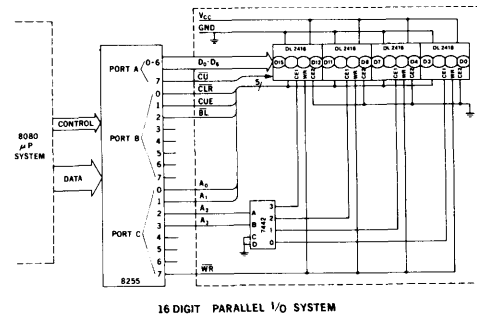

Figure 7

```

INIT:  MVI A,80H      ; CONTROL DATA MODE  $\phi$ 
        OUT CONTROL  ; LOAD CONTROL REGISTER
CURSR: MVI A,00H     ; CLEAR CURSOR DATA
        OUT PORT A   ; LOAD DATA PORT
        MVI B,0FH    ; SET CHARACTER COUNTER
CURSI: MOV A,B
        CALL DSPWT   ; WRITE SUBROUTINE
        DCR B        ; DECREMENT COUNTER
        JNZ CURSI   ; DIGIT  $\phi$ ?
        MOV A,B
        CALL DSPWT   ;
        MVI A,FFH    ; SET DATA FOR CONTROL
        OUT PORT B   ; LOAD CONTROL LINES
DISP:  LXI H, TABLE ; SET TABLE ADDRESS
DISP1: MOV A,M
        OUT PORT A   ; LOAD DATA PORT
        MOV A,B
        CALL DSPWT   ; LOAD ADDRESS AND CONTROL
        INX H        ; INCREMENT TABLE ADDRESS
        INR B        ; INCREMENT COUNTER
        MVI A,10H   ; SET # OF DIGITS
        CMP B
        JNZ DISP1   ; 16 CHARACTERS?
        HALT        ; END OF PROGRAM
DSPWT: ORI F0H      ; SET CONTROL BITS OFF
        OUT PORT C   ; LOAD CONTROL
        ANI 7FH     ; SET WRITE BIT ON
        OUT PORT C   ; LOAD WRITE
        ORI F0H     ; SET WRITE BIT OFF
        OUT PORT C   ; LOAD CONTROL
        RET
TABLE: DB           ; 0C3H
        DB           ; 0C9H
        DB           ; 0D4H
        DB           ; 0D3H
        DB           ; 0C1H
        DB           ; 0D4H
        DB           ; 0CEH
        DB           ; 0C1H
        DB           ; 0C6H
        DB           ; 0A0H
        DB           ; 0D3H
        DB           ; 0D4H
        DB           ; 0C8H
        DB           ; 0C7H
        DB           ; 0C9H
        DB           ; 0CCH
    
```

I/O OR MEMORY MAPPED ADDRESSING

Some designers may wish to avoid the additional cost of a parallel I/O in their system. Structuring the addressing architecture for the DL-2416 to look like a set of peripheral or output devices (I/O mapped) or RAM's and ROM's (memory mapped), is very easy. Figure 8 shows the simplicity of interfacing to microprocessors, such as 8080, Z80 and 6502 as examples.

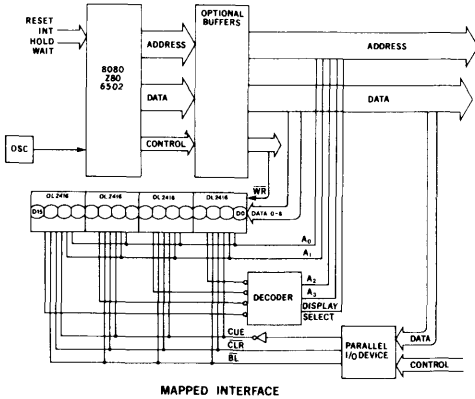

Figure 8

The interface with the 6800 microprocessor in Figure 9 illustrates the need for designers to check the timing requirements of the DL-2416 and the μP . The typical data output hold time is only 30 ns for $DBE = \phi 2$ timing; two inverters in the DBE line are added to increase the data output hold time for compatibility with the 50 ns minimum spec of the DL-2416.

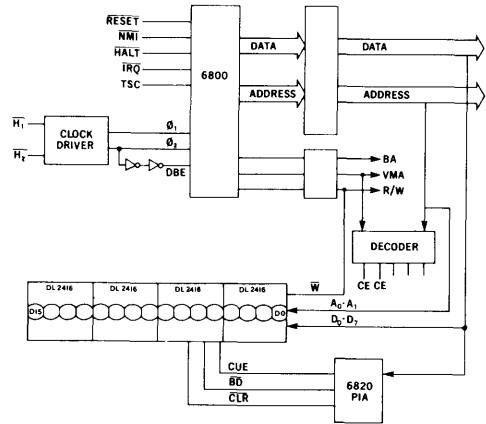

Figure 9

CONCLUSION

Note that although other manufacturer's products are used in examples, this application note does not imply specific endorsement, or recommendation or warranty of other manufacturer's products by Litronix.

The interface schemes shown demonstrate the simplicity of using the DL-2416 with microprocessors. The slight differences encountered with various microprocessors to interface with the DL-2416 are similar to those encountered when using different RAM's. The techniques used in the examples were shown for their generality. The user will undoubtedly invent other schemes to optimize his particular system to its requirements.

APPLYING THE DL-1414 Intelligent Display™

by Dave Takagishi

This application note is intended to serve as a design and application guide for users of the DL-1414 alpha-numeric intelligent display. The information presented covers device electrical description and operation, considerations for general circuit design, and interfacing the DL-1414 to microprocessors.

ELECTRICAL & MECHANICAL DESCRIPTION

General

The internal electronics in the DL-1414 intelligent display eliminates all the traditional difficulties of using multi-digit light emitting displays (segment decoding, drivers and multiplexing). The intelligent display also provides internal memory for the four digits. This approach allows the user to asynchronously address one of four digits, and load new data without regard to the LED multiplex timing.

Figure 1 is a block diagram of the DL-1414. The unit consists of four 17 segment monolithic LED die and a single CMOS integrated circuit chip. The LED die are magnified to a height of 112 mils by the built-in lenses. The IC chip contains 17 segment drivers, four digit drivers, 64 character ROM, four word x 7 bit Random Access Memory, oscillator for multiplexing, multiplex counter/decoder, address decoder and miscellaneous control logic.

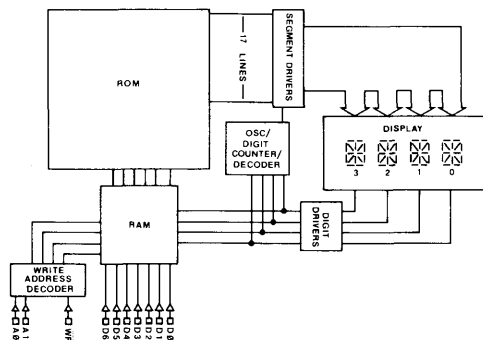

DL-1414 Block Diagram

FIGURE 1

PACKAGING

Packaging consists of an injection-molded plastic lens which also serves as an "encapsulation shell" since it covers five of the six "faces". The assembled and tested substrate (ceramic or "PTF" multilayer) is placed within the shell and the entire assembly is then filled with a water-clear IC-grade epoxy.

This yields a very rugged part which is quite impervious to moisture, shock and vibration. Although not "hermetic", the device will easily withstand total immersion in water/detergent solutions.

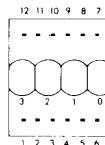

TOP VIEW

Pin	Function	Pin	Function
1	D5 Data Input	7	Gnd
2	D4 Data Input	8	D0 Data Input (LSB)
3	WR Write	9	D1 Data Input
4	A1 Digit Select	10	D2 Data Input
5	A0 Digit Select	11	D3 Data Input
6	V _{CC}	12	D6 Data Input (MSB)

PIN FUNCTION

FIGURE 2

ELECTRICAL INPUTS TO THE DL-1414

- V_{CC} POSITIVE SUPPLY +5 volts
- Gnd GROUND
- D0-D6 DATA LINES

The seven data input lines are designed to accept the first 64 ASCII characters. See Figure 3 for character set. (The DL-1414 interprets all undefined codes as a blank).

A₀, A₁ ADDRESS LINES

The address determines the digit position to which the data will be written. Address order is right to left for positive-true logic.

WR

WRITE (Active Low).

Data and address to be loaded must be present and stable before and after the trailing edge of write. (See data sheet for timing info).

	D0		L		H		L		H		L		H	
	D1	D2	L	L	L	H	H	H	L	L	L	H	H	H
D6 D5 D4 D3														
L H L L			.	"	#	9	%	&	'					
L H L H			<	>	*	+	/	-	.	'				
C H H L	0	1	2	3	4	5	6	7						
L H H H	8	9	:	:	/	=	Δ	?						
H L L L	A	B	C	D	E	F	G							
H L L H	H	I	J	K	L	M	N	O						
H L H L	P	Q	R	S	T	U	V	W						
H L H H	X	Y	Z	[\]	^	_						

All Other Input Codes Display "Blank"

CHARACTER SET

FIGURE 3

OPERATION

Multiplexed display systems sequentially read and display data from a memory device. In synchronous systems, control circuitry must compare the location of data to be read to the location or position of new data to be stored or displayed, i.e., synchronize before a Write can be done. This can be slow and cumbersome.

Data entry in "intelligent displays" is asynchronous and may be done in any random order. Loading data is similar to writing into a RAM. Each digit has its own memory location and will display until replaced by another code.

The waveforms of Figure 4 demonstrate the relationships of the signals required to generate a Write cycle. (Check individual data sheet for minimum values.) As can be seen from the waveforms, all signals are referenced from the rising or trailing edge of Write.

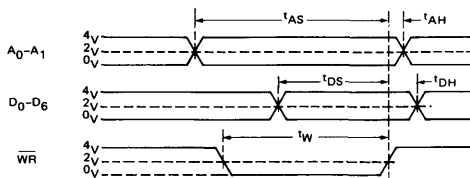

WRITE CYCLE WAVEFORM

FIGURE 4

WR	ADDRESS		DATA INPUT							DIGIT 3	DIGIT 2	DIGIT 1	DIGIT 0
	A ₁	A ₀	D6	D5	D4	D3	D2	D1	D0				
H	X	X	X	X	X	X	X	X	X	NO CHANGE	NO CHANGE	NO CHANGE	NO CHANGE
L	L	L	H	L	L	L	L	L	H	NO CHANGE	NO CHANGE	NO CHANGE	A
L	L	H	H	L	L	L	L	H	L	NO CHANGE	NO CHANGE	B	A
L	H	L	H	L	L	L	L	H	H	NO CHANGE	C	B	A
L	H	H	H	L	L	L	H	L	L	D	C	B	A
L	L	L	H	L	L	L	L	H	H	D	C	B	E
L	L	L	H	L	L	L	L	H	H	D	K	B	E
L	-	-	-	-	-	-	-	-	-	SEE CHARACTER SET			

X = DON'T CARE

DATA LOADING TABLE

FIGURE 5

GENERAL DESIGN CONSIDERATIONS

Using positive true logic, address order is from right to left. For left to right address order, use the "ones complement" or simple inversion of the addresses.

For systems with only a 6-bit (abbreviated ASCII) code format, Data Line D6 cannot be left open. Data D6 must be the complement of Data Line D5.

When using DL-1414's on a separate display board having more than two feet of cable length, it may be necessary to buffer all DL-1414 inputs. This is most easily achieved with Hex non-inverting buffers such as the 74365. The object is to prevent transient current in the DL-1414 protection diodes. The buffers should be located on the display board near the DL-1414's.

Local power supply bypass capacitors are also needed in many cases. These should be 6 or 10 volt, tantalum type having 10 μ F or greater capacitance. Low internal resistance is important due to current steps which result from the internal multiplexing of the DL-1414.

If small wire cables are used, it is good engineering practice to calculate the wire resistance of the ground plus the +5 volt wires. More than 0.1 volt drop, (at 25 mA per digit worst case) should be avoided, since this loss is in addition to any inaccuracies or load regulation limitations of the power supply.

The 5-volt power supply for the DL-1414's should be the same one supplying V_{CC} to all logic devices which drive the display devices. If a separate supply must be used, then local buffers using hex, non-inverting gates should be used on all DL-1414 inputs and these buffers should be powered from the display power supply. This precaution is to avoid logic inputs higher than display V_{CC} during power up or line transients.

INTERFACING THE DL-1414

A general and straight-forward interface circuit is shown in Figure 6. This scheme can easily interface to μ P systems or any other systems which can provide the seven data lines, appropriate address and control lines.

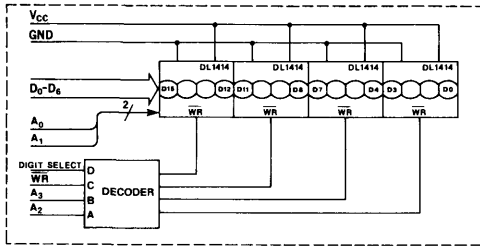

GENERAL INTERFACE CIRCUIT
FIGURE 6

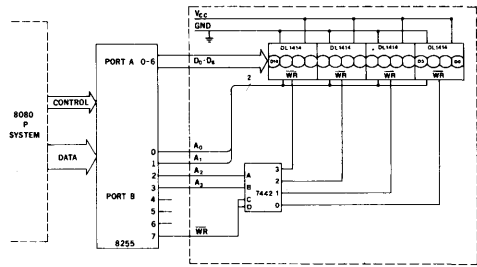

16 DIGIT PARALLEL I/O SYSTEM
FIGURE 8

The DL-1414 does not have a chip enable input. Therefore, each DL-1414 in a system requires its Write pulse be gated with appropriate address signals. Figure 7A shows the use of a 74154 decoder (4 line to 16 line) for up to a 64 character display. Using the G1 input for display select (address select in a memory mapped system) and the G2 input to gate the Write signal. Another approach (Figure 7B & 7C) which minimizes logic for a 16 or 32 digit display takes advantage of decoding scheme of the 7442 decoder.

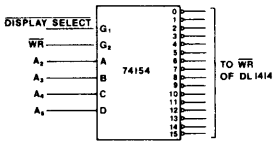

FIG. 7A

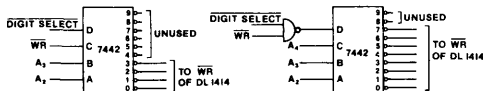

FIG. 7B

FIG. 7C

GATING THE WRITE PULSE

FIGURE 7

SAMPLE I/O PROGRAM

```

INIT:  MVI A,80H      ; CONTROL DATA MODE 0
        OUT CONTROL  ; LOAD CONTROL REGISTER
        MVI B,00H    ; SET COUNTER = 0
DISP:  LXI H,TABLE   ; SET TABLE ADDRESS
DISP1: MOV A,M       ; MOVE TABLE DATA TO ACCUMULATOR
        OUT PORTA    ; LOAD DATA PORT
        MOV A,B
        CALL DSPWT   ; LOAD ADDRESS AND CONTROL
        INX H        ; INCREMENT TABLE ADDRESS
        INR B        ; INCREMENT COUNTER
        MVI A,10H   ; SET # OF DIGITS
        CMP B
        JNZ DISP1   ; 16 CHARACTERS ?
        HALT        ; END OF PROGRAM
DSPWT: ORI F0H      ; SET CONTROL BITS OFF
        OUT PORTB   ; LOAD CONTROL
        ANI 7FH     ; SET WRITE BIT ON
        OUT PORTB   ; LOAD WRITE
        ORI F0H     ; SET WRITE BIT OFF
        OUT PORTB   ; LOAD CONTROL
        RET
TABLE: DL      ; 0C3H
        DB      ; 0C9H
        DB      ; 0D4H
        DB      ; 0D3H
        DB      ; 0C1H
        DB      ; 0D4H
        DB      ; 0CEH
        DB      ; 0C1H
        DB      ; 0C6H
        DB      ; 0A0H
        DB      ; 0D3H
        DB      ; 0D4H
        DB      ; 0C8H
        DB      ; 0C7H
        DB      ; 0C9H
        DB      ; 0CCH
    
```

PARALLEL I/O

The parallel I/O device of a microprocessor can easily be connected to the circuit in Figure 6. One eight bit output port can provide the seven input data bits. Another eight bit output port can contain the address and control signals.

Figure 8 illustrates a 16-character display with an 8080 system using the 8255 programmable peripheral interface I/O device. The following program will display a simple 16-character message using this interface.

I/O OR MEMORY MAPPED ADDRESSING

Some designers may wish to avoid the additional cost of a parallel I/O in their system. Structuring the addressing architecture for the DL-1414 to look like a set of peripheral or output devices (I/O mapped) or RAM's and ROM's (memory mapped), is very easy. Figure 9 shows the simplicity of interfacing to microprocessors, such as 8080, Z80 and 6502 as examples.

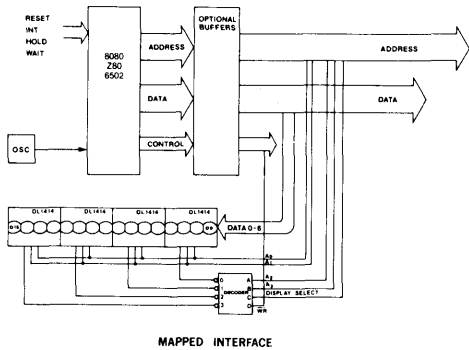

FIGURE 9

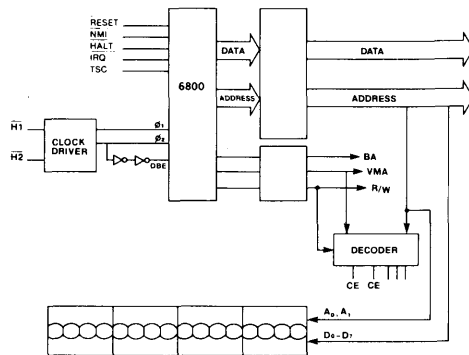

FIGURE 10

The interface with the 6800 microprocessor in Figure 10 illustrates the need for designers to check the timing requirements of the DL-1414 and the μP . The typical data output hold time is only 30 ns for DBE = $\phi 2$ timing; two inverters in the DBE line are added to increase the data output hold time for compatibility with the 50 ns minimum spec of the DL-1414.

CONCLUSION

Note that although other manufacturer's products are used in examples, this application note does not imply specific endorsement, or recommendation or warranty of other manufacturer's products by Litronix.

The interface schemes shown demonstrate the simplicity of using the DL-1414 with microprocessors. The slight differences encountered with different microprocessors to interface with the DL-1414 are similar to those encountered when using different RAM's. The techniques used in the examples were shown for their generality. The user will undoubtedly invent other schemes to optimize his particular system to its requirements.

GUIDELINES FOR HANDLING AND USING Intelligent Displays™*

by Malcolm Howard, David Takagishi

IMPORTANT!

This Appnote contains vital information for optimum design and performance of Intelligent Displays.™

Litronix Intelligent Displays are four and eight digit LED display modules, having a 16, 17 or 22 segment font and an on-board CMOS integrated circuit driver. The CMOS chip provides segment decoding, drivers, multiplexing and memory for easy interfacing to most microprocessors.

Since Litronix began manufacturing the Intelligent Display in 1978, several questions concerning their use have arisen. This application note is a guide for considerations in design and handling of this product.

SYSTEM DESIGN CONSIDERATIONS

The practical circuit design (i.e. design of PCB, etc.) should be such that the voltage to *any input* must *never exceed the power supply inputs* (i.e. $Gnd < V_{in} < V_{cc}$). If these conditions are not met, then malfunction, or at worst, device destruction can occur. The most common cause of this condition is *circuit noise* due to noise on the input leads and transient power supply changes.

Good Circuit Layout. The principles of good circuit layout are those for all logic circuitry, but the tolerance of MOS circuitry for deviations is much less than that of bipolar logic. The most important principle is to keep the lead length from the output of one device to the input of another as short as possible. This is to reduce the coupling effect between input signals.

Buffering. The second most common deviation from good design practice is the use of parallel tracking. Avoid PCB design which allow an interconnection track to run parallel to another. This is particularly true if one of the tracks is a power bus when the fluctuations

of power supply current can cause inductively coupled change in the input track. Possibly the worst example of parallel tracking is the ribbon cable: it is physically neat and convenient, but can be electrically destructive for the MOS circuits.

It is often necessary, because of the very nature of the Intelligent Display, to use ribbon cable from the CPU board to the display assembly board. In those circumstances for *cables over 30 cm* (12 inches), use a *TTL buffer for each used input*. This is especially true for noisy systems which have motors, relays, etc. The buffers must be on the display end of the cable; thus maintaining a minimum distance between their outputs and the display inputs. Long cables can be a poor transmission line for speed pulses. Line drivers, line receivers, or schmidt trigger gates may be required to shape pulses.

Voltage Transients. It has become common practice to provide 0.01 μf bypass capacitors liberally in digital systems. For intelligent displays, the emphasis is on adequate decoupling. Like other CMOS circuitry, the Intelligent Display controller chip has very low power consumption and the usual 0.01 μf would be adequate were it not for the LEDs. The module itself can, in some conditions, use up to 100 mA (multiplexed). In order to prevent power supply transients, capacitors with low inductance and high capacitance at high frequencies are required. This suggests a solid tantalum or ceramic disc for high frequency bypass. For larger displays, distribute the bypass capacitors evenly, keeping *capacitors as close to the power pins as possible*. Do not rely on existing on-board decoupling, *use a 10 μf and 0.01 μf for every 3 or 4 Intelligent Displays* to decouple the displays themselves, *at the displays*.

See Figure 1

*Intelligent Display is a trademark of Litronix.

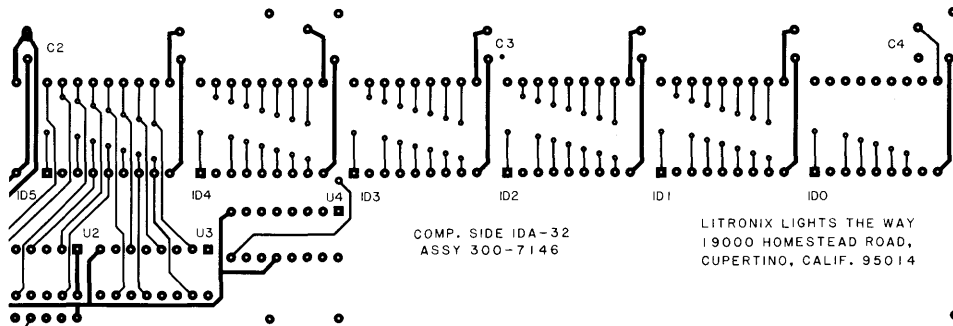

Figure 1 is an actual PCB layout for a line of DL 2416 intelligent displays. Capacitors are spaced evenly and close to the displays with room for additional capacitors should the system require them.

Functional Limitations. Several parameters in the intelligent display data sheets which may affect your design will be emphasized again. While this may not be destructive, it may affect reliability and/or functional operation. (See May 1981 or newer data sheet.)

1. The length of *time all cursors may be lit* should be 1 minute max.
2. The timing parameters for 25° C will increase with increased temperature.
3. The timing parameters will increase with increased Vcc.

MANUFACTURING CONSIDERATIONS

Handling. The static voltages generated by friction with modern synthetic materials (i.e. carpets, clothing, device carriers, etc.) are often measured in thousands of volts. Although there is usually little energy in these *static charges*, to MOS circuitry that energy is *sufficient to cause destruction* if applied between circuit inputs. Input protection diodes can minimize the vulnerability of the circuits, but there is a limit to their protection capabilities. Under certain conditions, static charges can exceed that limit. The most effective protection is to avoid the generation of static charges. When they are inevitable, prevent that charge from coming in contact with the device pins.

1. *Avoid touching the pins; handle the body only.*
2. *Keep the devices in anti-static tubes or conductive material when transporting.*
3. *Use conductive and grounded working area.* (conductive flooring, conductive work benches, individual wrist straps, etc.)

Intensity Codes. Display uniformity is a concern when two or more displays are in a system. Litronix has adopted a letter code to maintain a uniform display. It is recommended a single letter code be used per system. Because this may be difficult due to yield and delivery, adjacent codes (i.e. D with E or E with F) can be used with minimal problems. Jumping over a code (i.e. D with F) may be noticed by the most critical observer.

Soldering. Because of the plastic housing of the Intelligent Displays, it is necessary to control the solder temperature, soldering time and solder distance. A *maximum of 260° C* for 3 seconds at a distance of greater than 1/16 inch is required. An additional requirement for wave soldering is the Intelligent Display package cannot exceed 70° C.

Cleaning. The cleaning process for the Intelligent Displays is crucial to maintain the optical performance of the plastic housing. The solvent that *cannot* be used on the Intelligent Display product is alcohol. Alcohol will attack the lens material causing cracking, crazing and destruction of the clear optical properties of the lens.

In the *suggested category* are the chlorinated hydrocarbons (Acetone, 1,1,1 Trichloroethane, etc.) or freon TF, freon TA or warm DI water. One note of caution, do not specify a freon solvent without first finding the chemical composition. Some manufacturers use some form of alcohol as an additive, so beware.

QUALITY CONTROL AT Litronix

Although they work very closely together under one charter, reliability and quality assurance are in fact separate groups, with distinct responsibilities.

Quality Assurance sees that the product is made right.

Reliability makes sure it works right after it's built.

Quality Assurance

The Quality Assurance function monitors all aspects of day-to-day production to ensure that all materials, processes, manufacturing, test equipment, and piece parts meet the standard necessary to ensure high-quality, reliable devices.

The flowchart at right shows the basic quality control monitors built into each stage of LED production,

from GaAs ingot growth through diffusion and assembly to final shipment. QA performs lot-sampling inspections and acceptance-gate functions after the final assembly process in accordance with its particular specifications. The finished product undergoes thorough electrical, optical, dimensional and visual inspections.

Reliability

Component reliability at Litronix is ensured through routine monitoring and special testing activities.

Routine Monitoring: Maintaining this program gives us a continually updated measure of product reliability for specific operating environments. Typical tests include: temperature cycling, thermal shock, temperature and humidity, high- and 25°C- temperature burn-in (DC), high- and low-temperature storage and intermittent operating life.

We select all samples randomly from standard material entering finished goods inventory to ensure that test results reflect *current* manufacturing performance. For Read/Record samples; luminous intensity, forward voltage, and reverse current are read at each test point. After summarizing test data, we flag and isolate any group below the acceptable performance level.

Special Testing: This function covers a broad scope of environmental or life-stress tests, which are followed by close observation of any

changes in a product's characteristics. How a sample performs under the laboratory's highly accelerated conditions indicates its reliability within the expected operating life and environment. Among other factors, the confidence level of this conclusion is influenced by the number of parts tested, the validity of the test conditions and the accuracy of pre- and post-test measurements.

Some of the many possible reasons for special testing include:

- New product performance
- New processes
- New manufacturing technique
- New material quality
- Special customer specifications
- Long-term reliability prediction

Reliability also focuses on failure analysis. To determine a cause of failure, we selectively test and dissect a device so we can localize and identify its failure mechanism. This selective isolation further enables us to gauge the precise effect of stresses applied in reliability testing.

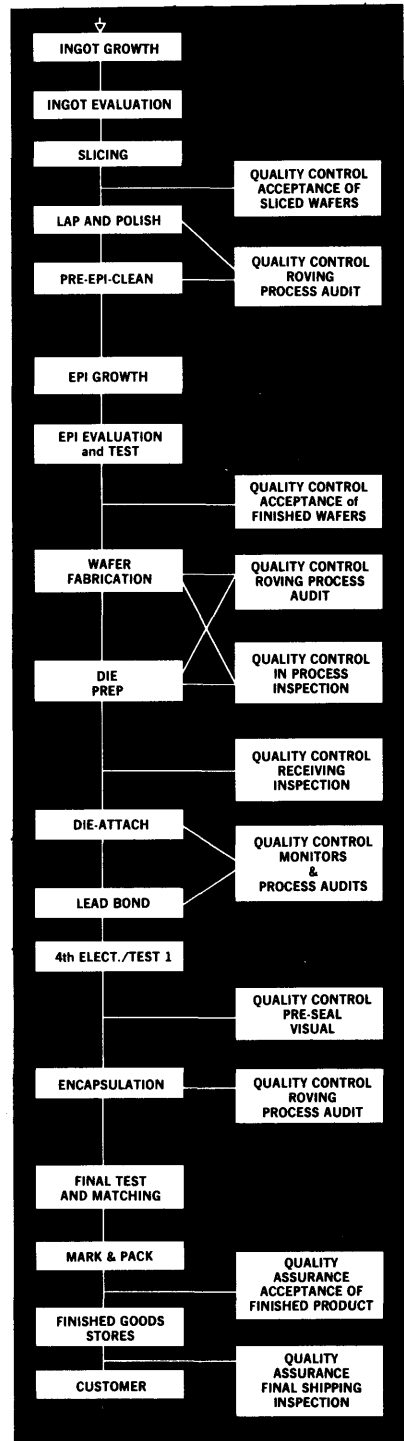

RELIABILITY TEST DATA

TYPE OF TEST	LAMPS	STANDARD DISPLAYS	Intelligent Displays™	OPTOISOLATORS
TEMPERATURE CYCLE (T/C)	332,850 Cycles 38 Failures	90,500 Cycles 15 Failures	—	32,930 Cycles 4 Failures
LIFE TEST (L/T)	5,172,000 Hours 5 Failures FR = .12%/1K hrs. MTBF = 820,000 Hours	2,798,000 Hours 6 Failures FR = .26%/1K hrs. MTBF = 390,000 Hours	502,000 Hours 1 Failure FR = .4%/1K hrs. MTBF = 250,000 Hours	2,022,000 Hours 1 Failure FR = .098%/1K hrs. MTBF = 1,000,000 Hours
THERMAL SHOCK (T/S)	152,550 Cycles 6 Failures	42,625 Cycles 11 Failures	4,500 Cycles 2 Failures	—
HIGH TEMP BURN IN LIFE TEST (HI BI)	285,000 Hours 0 Failures	334,000 Hours 0 Failures	—	—
TEMPERATURE & HUMIDITY (T & H)	765,965 Hours 19 Failures	446,832 Hours 4 Failures	596,160 Hours 10 Failures	84,168 Hours 1 Failure
INTERMITTENT OPERATING LIFE (IOPL)	21,645,800 Cycles 26 Failures	6,200,000 Cycles 17 Failures	—	415,000 Cycles 0 Failures

DESCRIPTION OF TESTS — RELIABILITY MONITOR PROGRAM FROM INVENTORY; N = 320

TYPE OF TEST	MILITARY STANDARD	PRETEST READINGS	TEST	POST TEST READINGS
TEMP CYCLE (T/C)	MIL STD 883B, Method 1010.2	GO/NO/GO N = 38	10 Cycles per sub group, 15 minute dwell, 5 second transfer time, maximum storage temperature ranges vary by product	GO/NO/GO
LIFE TEST (L/T)	MIL STD 883B, Method 1005.2	Read/Record N = 38	Room temperature burn in at maximum rated conditions, 1000 hours duration	Read/Record at 168, 500 and 1000 hours
THERMAL SHOCK (T/S)	MIL STD 883B, Method 1011.1	GO/NO/GO N = 38	15 cycles: boiling water; then ice water with 5 minute dwell time at each extreme	GO/NO/GO
HIGH TEMP BURN IN (HI BI)	MIL STD 883B, Method 1005.2	Read/Record N = 38	Maximum rated operating temperature determined from product specifications and derated current as compensation for thermal dissipation, 1000 hours duration	Read/Record at 168, 500 and 1000 hours
TEMPERATURE & HUMIDITY (T&H)	MIL STD 883B, Method 1004.2	GO/NO/GO N = 38	Steady state 85°C - 85% RH (Relative humidity), 250 hours maximum	GO/NO/GO
INTERMITTENT OPERATING LIFE (IOPL)	MIL STD 883B, Method 1006	Read/Record N = 38	3 minutes on, 3 minutes off at room temperature. 1000 cycles	Read/Record at 1000 cycles
† HIGH TEMPERATURE STORAGE (HTS)	MIL STD 883B, Method 1008.1	Read/Record N = 38	Maximum rated temperature for for 1000 hours	Read/Record at 168, 500 and 1000 hours
† LOW TEMPERATURE STORAGE (LTS)	—	Read/Record N = 38	Minimum rated temperature for 1000 hours	Read/Record at 168, 500 and 1000 hours

DEFINITIONS

FR Failure Rate
 MTBF Mean Time Between Failures
 N Sample Size

† Tests Instituted Mid 1979

Litronix A Siemens Company

OPTOELECTRONICS CATALOG

INTERNATIONAL EDITION

1982

Litronix A Siemens Company